



ORLIMAN®

Advancing for your well-being



ORTHOPEDIC PRODUCTS

TRAUMATOLOGY | RHEUMATOLOGY | REHABILITATION | SPORT MEDICINE | ORTHOPEDICS



ORLIMAN[®]



ORLIMAN[®]

Advancing for your well-being



Advancing for your well-being

INTRODUCTION

In Orliman, we believe that our greatest satisfaction is achieving well-being for others through quality products. Thanks to our customers and professionals in medicine who trust us and our products, this has become a reality. That is why our human team at Orliman strives each day to attain that objective with enthusiasm.

A COMPANY WITH HISTORY

Orliman's origins go back to an orthopaedic family business, which started more than 70 years ago, and in the last decade it has become a limited company committed to the development and production of standard orthopaedic products.

Our business strategy is based on continual research of new products, quality and performance thereof and a personalised service to customers with a permanent interpretation of both their and the market's demands.

Our constant investment in technology, research and human resources, as well as close cooperation between the different departments make Orliman an agile company with an outlook to the future that also cooperates with technological institutes or renown prestige in order to evaluate and analyse our products.

Orliman is backed by the domestic and international markets and looks to the future with optimism, while keeping sight of the initial strategic criterion that have taken us to where we are now.





PRODUCTS RANGE

Our range includes:

- Orthosis for lower limbs
- Orthosis for the trunk
- Orthosis for upper limbs
- Thermo-compressor orthosis
- Insoles and heelcups
- Podiatry
- Technical help

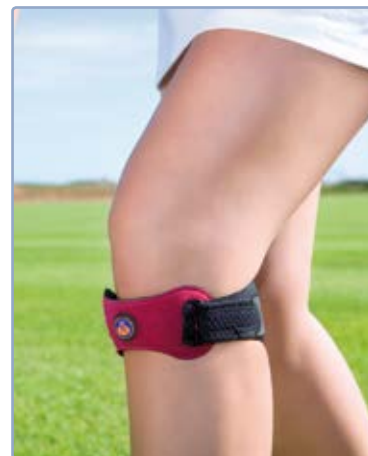

WE ARE INCREASING OUR SPACE

We are multiplying our premises with a new headquarters of over 10,000 m² which contains all of the technological and professional means that a leading company requires.



WORKFORCE

The workforce at Orliman is made up of professionals within each speciality who receive continuous training to ensure they are suitably informed about products and technological and medical advances, who strive to better themselves on a daily basis in order to attend to the needs of our customers.

In this way, not only do we extend our range of products, but we also achieve optimum results in their qualities, purposes and therapeutic effects, increasing their performance for the end user.



INTERNATIONAL PRESENCE

An important part of Orliman's business is export, which began intensely and has continued in the same way over the last years. The results obtained in recent years have been excellent thanks to the good value for money ratio of our products and a well defined sales policy that suitably covers the needs of each market.

Orliman is present in the five continents.



CERTIFIED

Orliman guarantees that most all your products are certified to the Oeko-tex standard 100 which proves the absence of substances that are hazardous and/or toxic to human health.

The products described in this catalogue are available at the best surgical aids shops in your town or city and conform to the Royal Decree 1591/2009 (Council Directive 93/42/EE).

The aforementioned products have been subjected to risk analysis in accordance with UNE-EN ISO 14971 and all the existing risks have been minimised.

All trials and tests have been carried out in accordance with the European norm, UNE-EN 22523 for prostheses and orthosis.

The company is certified with ISO 13485 and ISO 9001.

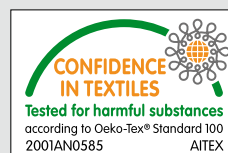

ASQUAL



COMMUNICATION AND INTERNET

Due to the demand for information of our customers and professionals, Orliman, apart from the catalogues and brochures, has developed different tools over the last few years.

We quarterly issue a magazine "Orliman Communicates" that informs all our customers and professionals about new products, news in the medical sector, training, etc.

Another of our tools is our website which is continually updated and where customers can read news, see new products, place orders, consult scientific articles related to orthopaedics, etc.

We periodically issue electronic bulletins to keep customers punctually informed about new products, news related to the sector, promotions, etc. Our on-line product catalogue (multi-language), divided into parts of the body, will help you find what you are looking for through a search engine by references, pathologies, family, etc.

Well, that's all it takes, if you want to be punctually informed, subscribe completely free to the magazine or the electronic bulletin by contacting us by: Telephone, fax, e-mail Visiting our website.

► Sign up through our website or social network link.

facebook

 <http://www.facebook.com/OrlimanOp>

YouTube

 <http://www.youtube.com/user/OrlimanOp>



www.orliman.com



Index















Orthosis for the Trunk / Harness

- 11  **Lumbitron® Elite** ▶Lumbosacral Back Supports
- 12  **Lumbitron® Elite Duo** ▶Lumbosacral Back Supports
- 13  **Evotec®** ▶Semi-rigid Back Supports
- 14  **Dorso Evotec®** ▶Semi-rigid Dorso lumbar Back Supports
- 15  **Evotec® Forte** ▶Thermoplastic Module
- 16  **Lumbisil®** ▶Lumbosacral Back Supports
- 17  **Lumbitron®** ▶Lumbosacral & Lumbodorsal Back Supports
- 18  **Lumbitec®** ▶Semi-rigid Back Supports
- 19  **Jewett Hiper-Extensión Frame**
- 20  **Star Brace®** ▶Lumbosacral & Thoracic Lumbosacral Rigid Corsets
- 21  **Star Brace® Dynamic** ▶Lumbosacral Orthosis
- 22  **Star Brace® Dynamic Fix** ▶Lumbosacral Orthosis
- 23  **Knight Corset** ▶Lumbosacral Orthosis
- 24  **Modular dorso-lumbar Taylor orthosis** ▶Lumbosacral Orthosis
- 25  **Twin Shell Corset**
- 26  **Back Support Belts**
- 30  **Stomamed®** ▶Abdominal Supports For Ostomy Patients
- 31  **Sacroiliac belt** ▶Sacroiliac Back Supports
- 31  **Shoulder Supports**
- 32  **Trusses**
- 34  **Arnetec® Fix** ▶Technical Harnesses
- 36  **Arnetec®** ▶Restraining Harnesses

Head/Neck

- 42  **Cranial protection helmet**
- 42  **Cervical collars**

Orthosis for Upper Limbs

- 46  **Immobilisers** ▶Clavicle & Shoulder Immobilizers
- 48  **Abduction Arm Sling**
- 49  **Orthosis for positioning**
- 50  **Manutec®** ▶Wrist Support
- 52  **Manutec® Fix** ▶Bilateral Wrist Support
- 53  **Manutec® Fix Rizart** ▶Bilateral Wrist Support
- 54  **Manutec®** ▶Wrist Support & Splints in Thermoplastic
- 55  **Finger immobilising glove splint**
- 55  **Stack Splints**
- 56  **Immobilising Frog Finger Splint In Malleable Aluminium**
- 56  **Splints in Thermoplastic**
- 58  **Malleable aluminium hand brace**
- 59  **Epitex® Fix** ▶Epicondylitis Armband
- 60  **Epitex®** ▶Epicondylitis Armband
- 60  **Codisil®** ▶Orthosis for the Elbow
- 60  **Humertec®** ▶Orthosis for the Elbow
- 61  **Orthosis for arm and forearm in thermoplastic**
- 62  **Humerus Brace**
- 63  **Neuro-Conex®** ▶Shoulder Support and Forearm Strap





Orthosis for Lower Limbs

- 67  **Rodisil®** ▶Active knee support
- 69  **Pad-Fix®** ▶Patellar Knee Band
- 70  **3-Text®** ▶Functional Fabrics Orthosis
- 73 **Thigh support / Calf support** ▶Functional Fabrics Orthosis
- 74  **Orthosis & Knee Immobilisers**
- 76  **OCF EDU** ▶Functional Knee Orthosis
- 78  **Gonartec®** ▶Varus-Valgus Knee Support
- 79  **Hip Stabilizing Orthosis**
- 80  **Tobiplus®** ▶Orthosis for Ankle Control
- 81  **Altex®** ▶Orthosis for Ankle Control
- 81  **Orthosis for Ankle Control**
- 82  **Tobisil®** ▶Orthosis for Ankle Control
- 82  **Valfeet® AIR** ▶Air Inflatable Ankle Stabilising Orthosis
- 83  **Valtec®** ▶Ankle Stabilising Orthosis
- 83  **Leaf spring orthosis**
- 84  **Boxia®** ▶A.F.O. Drop Foot
- 86  **Orthosis for Ankle Control**
- 86  **Walkers by Orliman®** ▶Ankle Immobilizing Orthosis
- 88 **ORLIMAN LINERS**
- 90 **ORLIMAN Sleeves**

Pediatric

- 93  ▶Pediatric Orthosis

Neoprene/Elastic

- 101  **Thermo-med®** ▶Back Support Thermo-compression Orthosis
- 111  **Thermo-med® Origami** ▶Thermo-compression Orthosis
- 113  **ORLIMAN SPORT** ▶Elastic Supports
- 115  **Elastic** ▶Elastic Line

Foot

- 118  **SOFY-PLANT** ▶Silicone Insoles & Heels Cups
- 121  **SOFY-PLANT fine** ▶Silicone Insoles & Heels Cups
- 121  **SOFY-PLANT fine Lady** ▶Silicone Insoles & Heels Cups
- 122  **SOFY-PLANT gel** ▶Podology
- 128  **SOFY-PLANT mini** ▶Podology
- 128  **SOFY-PLANT Minifix** ▶Self-adhesive Podology
- 128  **SOFY-PLANT Miniplus** ▶Self-adhesive Podology
- 129  **SOFY-PLANT** ▶Self-adhesive Podology
- 130  **Hallux-Valgus** ▶Correctors
- 131  **Postoperative shoe**
- 132  **Special insole for diabetic foot and ulcerations**
- 133  **orliven** ▶Technical Socks

Advertising Material

- 138 **Advertising Material**

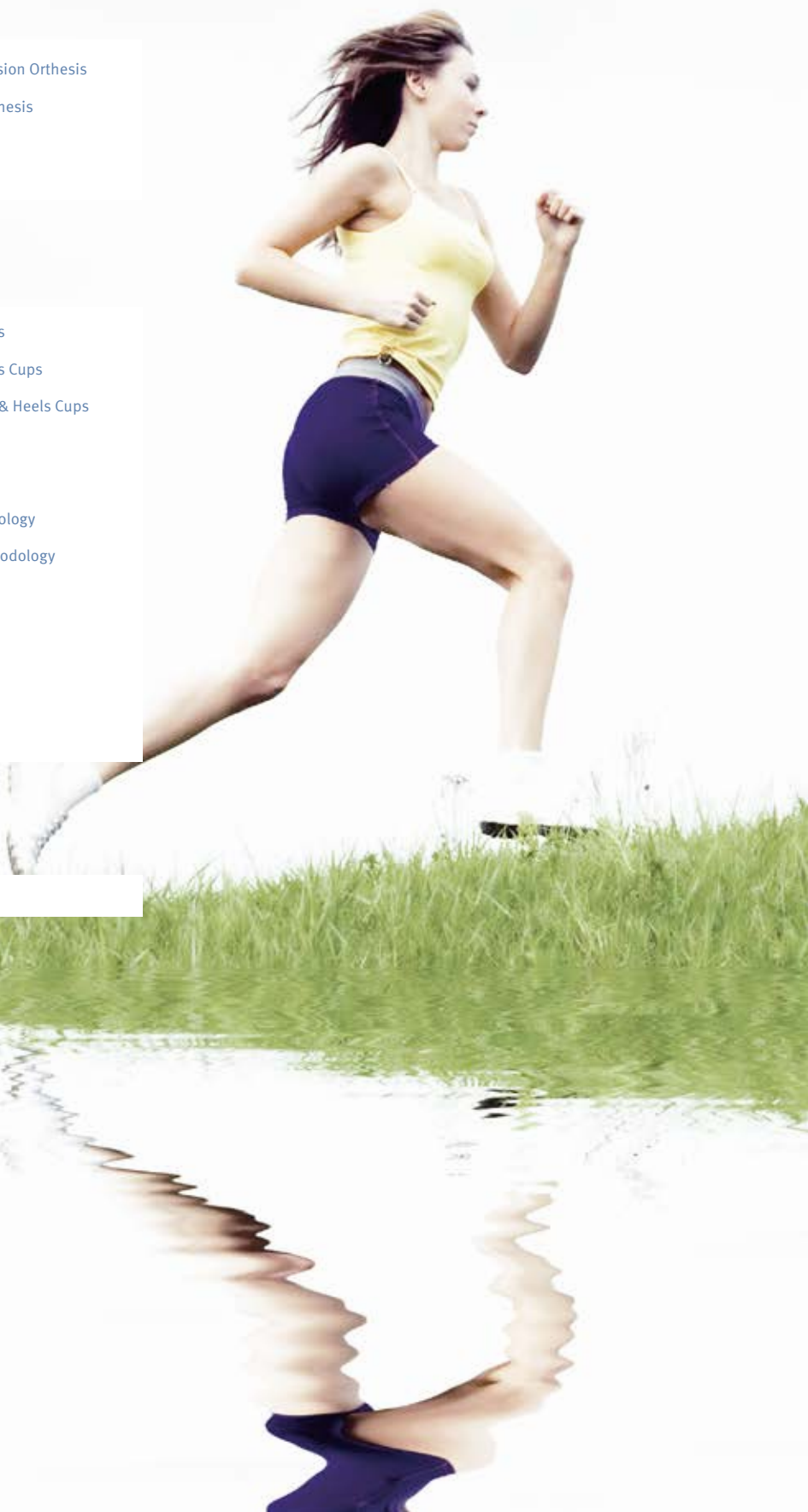

FUNCTIONAL ASSESSMENT CRITERIA FOR ORLIMAN PRODUCTS

The main functions of orthopaedic products and devices are fastening, compression, stabilisation and immobilisation.

The degree to which the materials, components and closure and adjustment systems used in their design fulfil these functions can be expressed on a scale of 0 to 5.

A definition of the characteristics of each function is provided below:

► FASTENING

The ability to join one element to another (device-patient) and prevent release.

► COMPRESSION

Volume reduction by means of pressure. The ability of the orthosis to apply external forces to a part of the patient's body.

► STABILISATION

A material's capacity to remain stable or revert to a position after becoming distorted. The ability of a device to keep an area of the patient's body in a desired position.

► IMMOBILISATION

The ability to reduce or restrict movement and keep it firm and constant. Reduction or restriction of any movement in a particular anatomical area.

ASSESSMENT

Fastening

- Absence of any system that produces specific fastening.
- Basic fastening systems by means of velcro or similar.
- Moderate fastening systems by means of velcro, straps or fasteners.
- Advanced fastening systems by means of straps with buckles or similar.
- Fastening and secure closure systems by means of buckles, magnets or similar.

Compression

- Absence of any type of compression.
- Made with low compression materials without tension adjustment systems.
- Made with moderate compression materials including compression adjustment systems and flexible support elements.
- Made with high compression materials including compression adjustment systems and rigid support elements.
- Made with high compression materials including mechanical and/or pneumatic compression adjustment systems and rigid thermoplastic support elements.

Stabilisation

- Absence of positioning elements to provide some degree of stabilisation.
- Basic stabilisation through its design and complementary elements.
- Good stabilisation in certain locations through its design, stabilising elements, stays, etc.
- Optimum stabilisation through its design, materials and support systems.
- Maximum immobilisation in all anatomical locations through its design, rigid structures and active components.

Inmobilization

- Absence of any elements that produce immobilisation.
- Slight restriction in the degree of mobility through product design.
- Good restriction in mobility in some locations through its design and the presence of components to fulfil that purpose.
- Optimum immobilisation in some locations through its design and the presence of mechanisms to partially restrict the mobility range.
- Maximum immobilisation in some or all anatomical locations through its design and the presence of mechanical elements to partially or totally restrict joint movement.



ANATOMIC ASPECTS

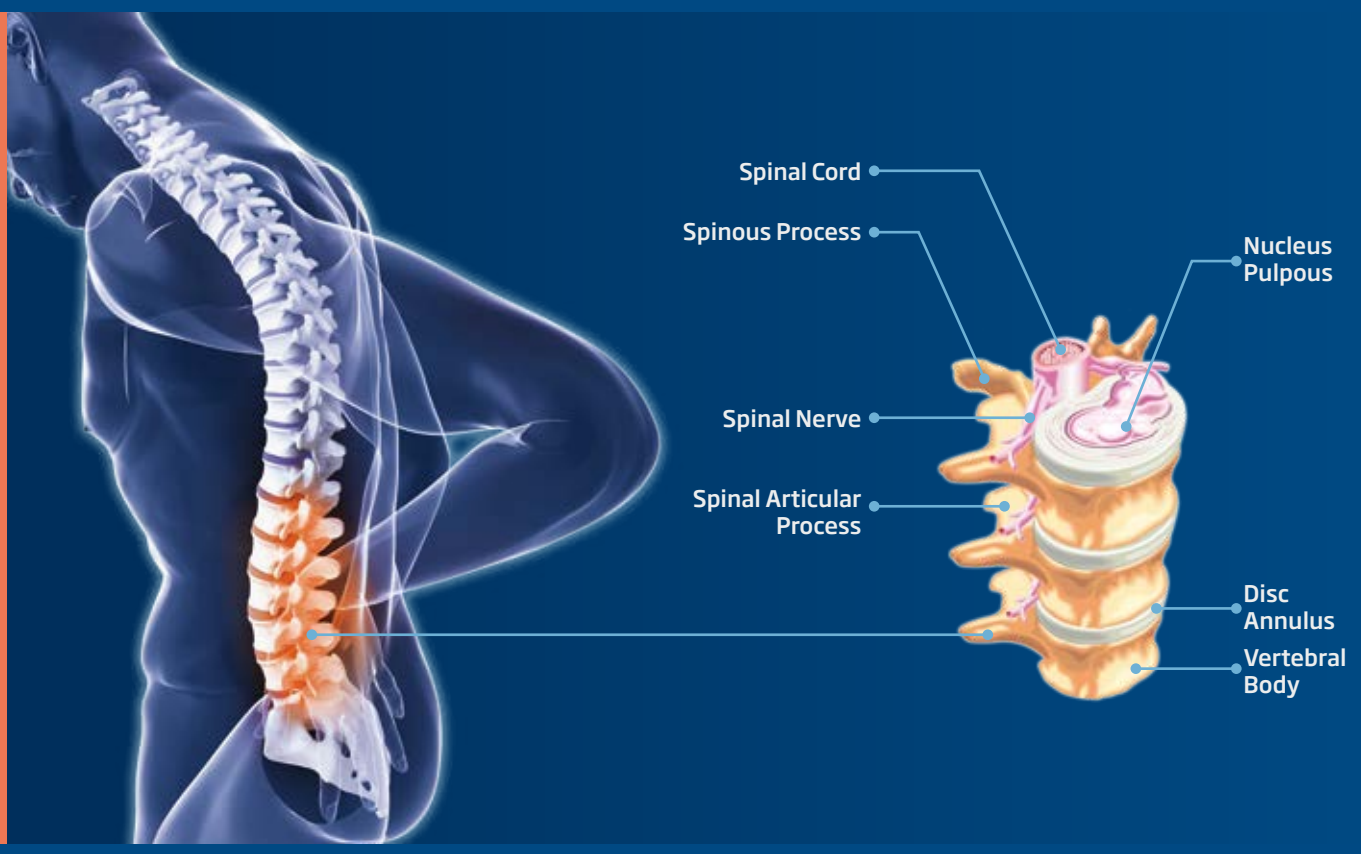
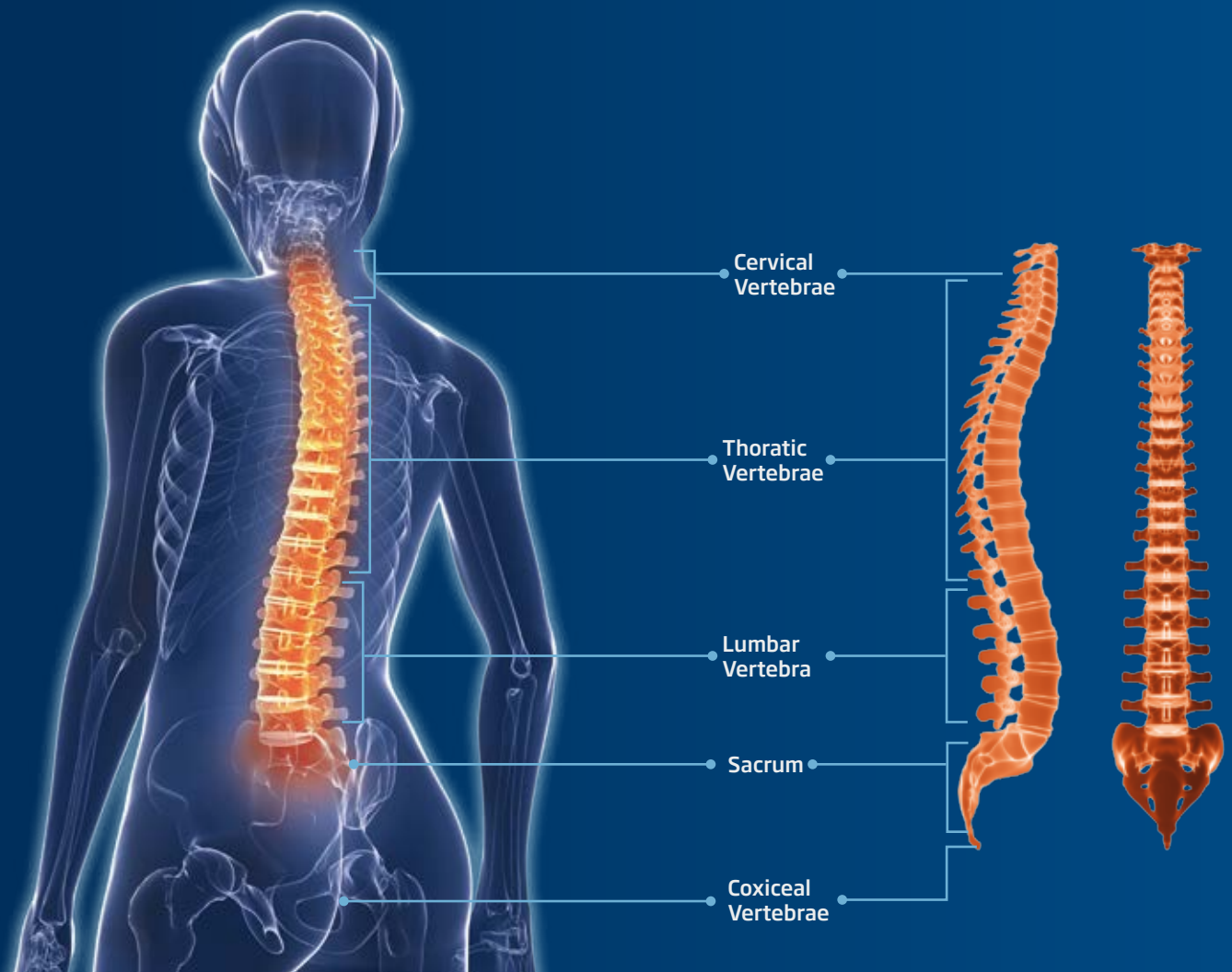

MAIN FEATURES

The new Lumbitron Elite belt is made with the latest generation materials: more resistant, elastic, lightweight and hardwearing, providing greater compression and extending the life of the product. Made of breathable multiband material, providing uniform compression due to its seamless, wireless technology, preventing annoying friction and loss of compression around the patient's body. Hook fasteners, specially designed for easy placement, due to the clips.

- *New design.*
- *Threadless seams.*
- *Adaptable.*

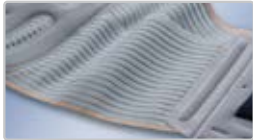

THREADLESS SEAMS

Made of breathable multiband material.



EASY PLACEMENT

Pins to facilitate the closure of the belt.



21 cm SHORT MODEL



Ref: **LTG-285** F ... C ... S ... I ...

LUMBOSACRAL BACK SUPPORT LUMBITRON ELITE

Ref: **LTG-275** F ... C ... S ... I ...

SHORT LUMBOSACRAL BACK SUPPORT LUMBITRON ELITE

Ref: LTG-285

SIZES	PERIMETER CM	TROCHANTER	FRONT HEIGHT	BACK HEIGHT
XXS/1	63-75			
XS/2	75-83		17 cm	
S/3	83-91			26 cm
M/4	91-99			
L/5	99-107			
XL/6	107-115			
XXL/7	115-123			

Characteristics:

Reinforced in the lower back region with four preformed steel stays, which are flexible and adaptable. The front part includes 2 flexible stays for improved consistency and abdominal restraint. Its inner part incorporates a foam lumbar pad which provides heat to the area, having a thermal effect, at the same time as providing selective compression in the lumbar region.

Suitable for:

- Lumbago.
- Lumbosciatica.
- Degenerative processes.
- Atony and muscular weakness.
- Pre- and post-surgical treatment.

Colour: Grey.

Components:

Belt + Foam lumbar pad.



Ref: LTG-275

SIZES	PERIMETER CM	TROCHANTER	FRONT HEIGHT	BACK HEIGHT
S/1	70-90			
M/2	90-110		14 cm	
L/3	110-130			21 cm

ACCESSORIES



Ref: LTG-105

LUMBAR REINFORCEMENT

The lumbar support can be ordered separately in the following sizes:

LTG-105 LUMBAR REINFORCEMENT SIZES	1	2	3	4
FOR LTG-285 BELT SIZES	1-2	3-4	5-6	7
FOR LTG-275 BELT SIZES	1	2	3	

ADAPTABLE MODULAR LUMBAR REINFORCEMENT FOR GREATER COMPRESSION

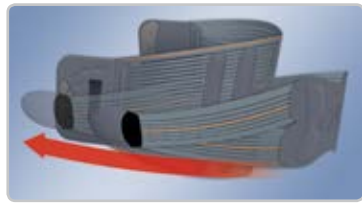

The belt also includes a lumbar reinforcement as an added feature for maximum support and compression. This can be removed if the pain subsides, converting it into a normal lumbosacral belt.



Manufactured in velour with hook fasteners on the inside which attach to the velour located at the rear on the outside of the belt. From here, there are 2 elastic straps at each end with hook fasteners, giving it greater compression.



The lumbar support can vary their position to optimize its efficiency (up or down).



At each end of the band, the fasteners have a pocket to accommodate the fingers, making it easier to fit.



21 cm SHORT MODEL



Ref: LTG-305 F ... C ... S ... I ...
SEMI-RIGID LUMBOSACRAL BACK SUPPORT LUMBITRON ELITE DUO

Ref: LTG-375 F ... C ... S ... I ...
SHORT SEMI-RIGID LUMBOSACRAL BACK SUPPORT LUMBITRON ELITE DUO

Ref: LTG-305

SIZES	PERIMETER CM
XXS/1	63-75
XS/2	75-83
S/3	83-91
M/4	91-99
L/5	99-107
XL/6	107-115
XXL/7	115-123

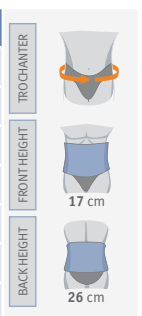

Characteristics:

Reinforced in the lower back region with four preformed steel stays, which are flexible and adaptable. The front part includes 2 flexible stays for improved consistency and abdominal restraint. Its inner part incorporates a foam lumbar pad which provides heat to the area, giving a thermal effect, at the same time as providing selective compression in the lumbar region.

Suitable for:

- Lumbago.
- Lumbosciatica.
- Degenerative processes.
- Atony and muscular weakness.
- Pre- and post-surgical treatment.
- Disc herniation.
- Spondylolysis and spondyloarthritis.

Colour: Grey.

Components:

Belt +Foam lumbar pad +Lumbar reinforcement.

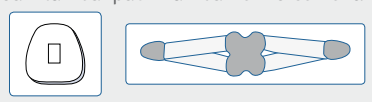

Ref: LTG-375

SIZES	PERIMETER CM
S/1	70-90
M/2	90-110
L/3	110-130

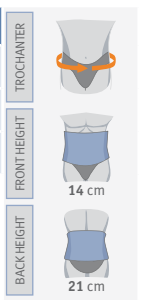

MAIN FEATURES



A semi-rigid posterior plate formed by four adaptable and preformed steel stays, and containment velour which is attached to the elastic material and to the stays thanks to a revolutionary fabrication system. Includes a lumbar cushion which provides heat in the area and can be easily removed.



Specially designed fastening system for facilitating fitting on geriatric patients or other patients with functional problems.



Elastic traction bands which allow better adjustment (both for men and women with a greater contour difference between the hips and waist) and elevation of the abdomen, an important characteristic of lumbar problems of which the majority are associated to prominent and fallen abdomens.

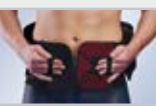
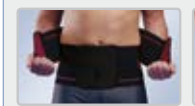

Fitting:
1- Easy mouldable stays.
2- Easy to use even for patients with difficulties or geriatric patients thanks to the finger slides.

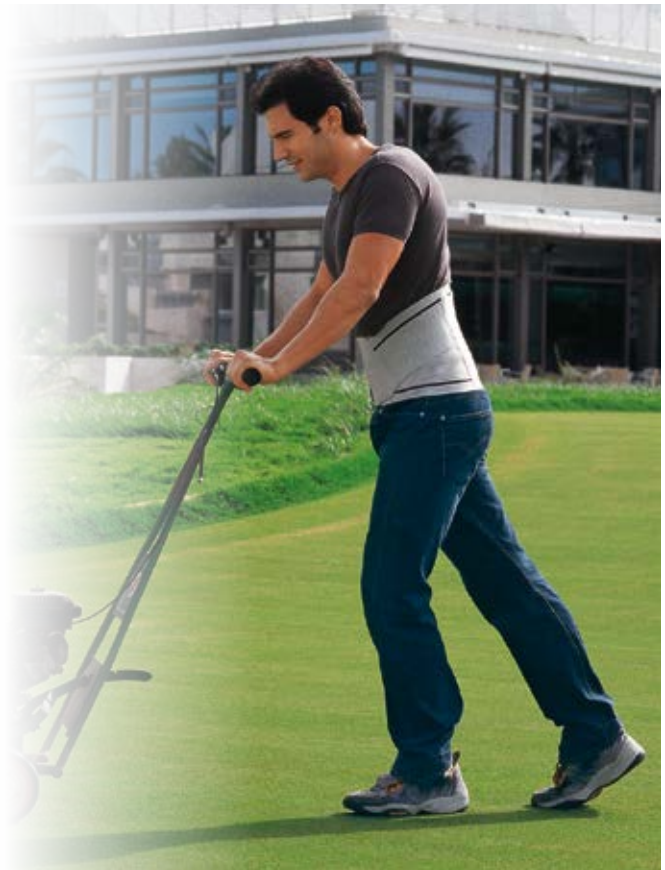

Ref.: EV-100 GREY Ref.: EV-200 BEIGE Ref.: EV-300 BLACK

SEMI-RIGID LUMBAR BACK SUPPORT

F ... C ... S ... I ...

Ref.: EV-101 GREY Ref.: EV-201 BEIGE Ref.: EV-301 BLACK

HIGH SEMI-RIGID LUMBAR BACK SUPPORT

F ... C ... S ... I ...

SIZES	PERIMETER CM	Ref: EV-100 / EV-200 / EV-300	Ref: EV-101 / EV-201 / EV-301
XXS/1	63-75		
XS/2	75-83		
S/3	83-91	16 cm	18 cm
M/4	91-99		
L/5	99-107	26 cm	30 cm
XL/6	107-115		
XXL/7	115-123		

Foam lumbar cushion colours:



NP-050: Beige.
NP-051: Blue.
NP-052: Black.

Characteristics:

Made from a dense elastic material which provides 50% more compression than those conventionally used for greater lumbar containment. Made with a threadless seam technique, avoiding bothersome rubbing.

Indications:

- Lumbago.
- Lumbosciatica.
- Degenerative processes.
- Weak and atonic muscles.
- Pre- and post-surgical treatment.
- Disc hernia.
- Spondylarthrosis.
- Spondylolysis.
- Strong lumbosacral support, perfect anatomic fit, easy to use and soft on the skin.

Colour:

- EV-100: Grey.
- EV-200: Beige.
- EV-300: Black.

MAIN FEATURES

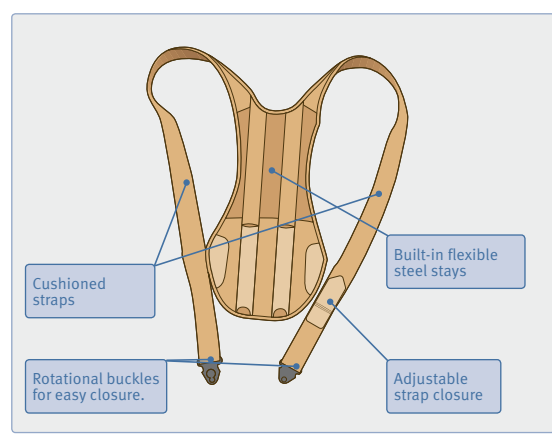

Bound with greater rigidity on the inside of the strap for greater adaptation to the dorsal area.

The dorsal piece allows height regulation depending on the morphology of the patient.

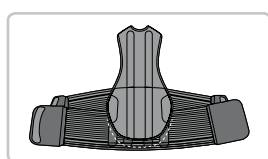
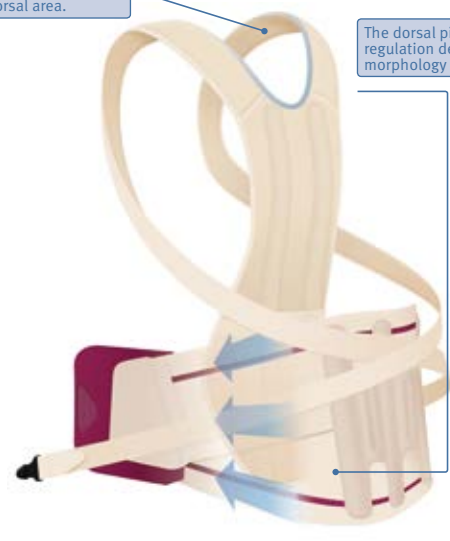

The dorsal piece allows height regulation depending on the morphology of the patient. According to the lumbosacral orthosis model Evotec which we offer we can regulate it from a minimum to a maximum of:
Short model: Minimum: 47 cm. - Maximum: 53 cm.
Long model: Minimum: 47 cm. - Maximum: 57 cm.

As can be seen in the illustration, the dorsal piece adapts perfectly to the inner part of the Evotec girdle, forming between them a single dorsolumbar support with straps and converting it to lumbosacral support as the patient recuperates.

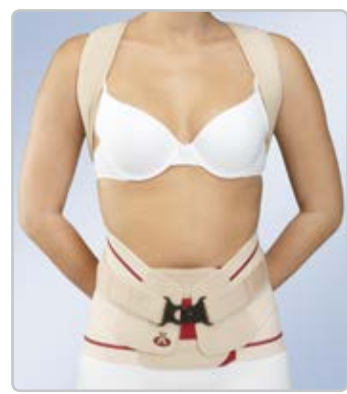
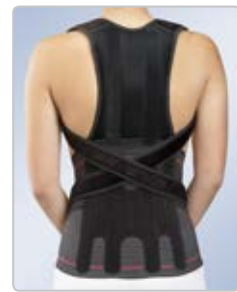
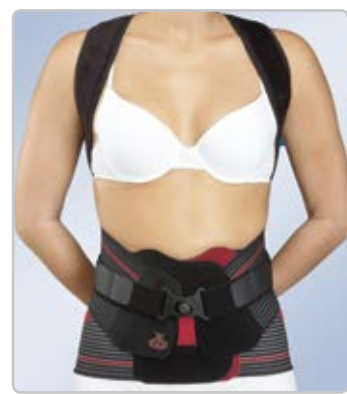

Ref.: EV-303 BLACK Ref.: EV-203 BEIGE

F ... C ... S ... I ...

ADAPTABLE DORSOLUMBAR MODULE DORSO EVOTEC

SIZES	ONE SIZE	
--------------	-----------------	--

Adaptations:
The Evotec dorsolumbar module can also be used together with the sacrolumbar module in thermoplastic Evotec Forte, thus obtaining a higher degree of immobilization and stabilization of the thoracolumbar segment. Parts request must clip for unite both supports.
Ref.: EVS-MD



- Characteristics:**
Front side Made of en transpirable honeycomb fabric and back made of soft boucle fabric. Built-in flexible steel stays, morphologically preformed to the dorsal zone. Elastic straps made of soft cushioned fabric, adaptable to adjust to the axilla zone and obtain greater comfort. New strap hook system with easy-to-close buckle. The dorsolumbar Dorso Evotec module is a single-size support which allows us to convert an Evotec lumbosacral orthosis into a thoracolumbosacral orthosis.
- Indications:**
 - Specially indicated in patients affected by kyphotic attitudes, vertebral wedging, dorsolumbar traumatism, infectious illnesses which affect the dorsal rachides, slipped disks, postoperative, osteoporosis and in all those cases in which the object is the correction of the kyphotic curve, and the antepulsion of shoulders.
 - The dorsal module can always adapt upon an Evotec lumbosacral support.
- Colour:**
EV-203: Beige.
EV-303: Black.
- Accessories:**
Stays can be ordered with most rigid steel Ref: PALA-AINOX-FORM/2544.

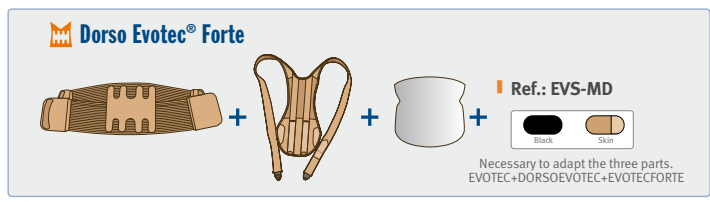

MAIN FEATURES

The Evotec back support is also complemented by a thermoplastic module with which we can achieve a more rigid orthosis: **EVOTEC FORTE**.





Ref.: EVM-100
BLUE (30cm)

Ref.: EVM-110
BLUE (37cm)

F ... **C** ... **S** ... **I** ...

LUMBOSACRAL MODULE IN THERMOPLASTIC

MODULE SIZES	BACK SUPPORT SIZES	RANGES	TROCHANTER	HEIGHT
1	1-2	63-83		 30 cm (EVM-100/200) 37 cm (EVM-110/210)
2	3	83-91		
3	4-5	91-107		
4	6-7	107-123		

Equivalencies for finding the correct module for each Evotec Back Support.





Characteristics:

Module made from low density polyethylene. Easy to fit for different body shapes. The upper tensor bands that go from the rear to the back can be fitted perfectly, even to body shapes that present large circumference differences between the hip and waist (men – women), as well as lifting the abdomen, an important characteristic for the orthotic treatment of the vertebral column. Perfect lateral immobilisation; the thermoplastic module is fixed onto the support by way of anchors. More aesthetically pleasing than other products on the market with these characteristics. **Maximum immobilization with the completely fitted module, when the ailment diminishes, the outer module can be removed leaving a semi-rigid support girdle.**

Indications:

- Degenerative disc conditions.
- Lumbar spondylarthrosis.
- Osteoporosis.
- Crushing.
- And in those cases where loading and lumbar vertebral movement is to be diminished.

Colour:

EVM-100:  Blue. / EVM-110:  Blue.
 EVM-200:  Beige. / EVM-210:  Beige.

MAIN FEATURES



Ref.: 9201
MEN

Ref.: 9202
WOMEN

F .. C ... S ... I ..

LUMBOSACRAL BACK SUPPORT WITH VISCO-ELASTIC PAD

SIZES	PERIMETER CM	TROCHANTER	FRONT HEIGHT
XS/1	70-80		16 cm
S/2	80-90		
M/3	90-100		
L/4	100-110		
XL/5	110-122		
XXL/6	122-135		

BACK-HEIGHT	9201	9202
	23,8 cm	1-2 23,8 cm 3-4-5 25 cm 6 26 cm

- Characteristics:** Made from three-dimensional breathable stockinette, it features a visco-elastic lumbar pad with 38 micromassage pimples, pre-formed shape, available in 2 models for men and women. It contains 2 flexible lumbar and 2 side stays to provide greater stability to the girdle. Front closure with hook and velour on the abdominal plate with interior reinforcement, and a finger loop for easy fitting.
- Indications:**
 - Lumbago, chronic lumbar pain associated with degeneration, muscle and ligament insufficiency and after orthotic treatment with rigid corsets.
 - As a prevention and protection method during sporting activities.
- Colour:** ■ Grey.



Ref.: 9202

ACCESSORIES



Ref.: AL070
VISCO-ELASTIC PAD

- Characteristics:** The therapeutic lumbar pad with pimpled surface enhances the function and effectiveness of the orthosis, and provides para-spinal musculature massage. Anatomically shaped.
- Colour:** ■ Blue.

SIZES ONE SIZE



Ref.: **LT-283**

F .. C ... S ... I ..

ONE SIZE/UNIVERSELLE LUMBAR BACK SUPPORT

SIZES	PERIMETER CM
1	75-91
2	91-115



Characteristics:

Breathable multi-band material, 8 rear steel malleable stays, front velcro fastening.

Indications:

- Lumbago.
- Lumbosciatica.
- Degenerative processes.
- Weak and atonic muscles.
- Pre- and post-surgical treatment.

Colour: Beige.



Ref.: **LT-284**
BEIGE

Ref.: **LTB-284**
WHITE

Ref.: **LTN-284**
BLACK

F .. C ... S ... I ..

LUMBAR BACK SUPPORT "LUMBITRON STABLE"

SIZES	PERIMETER CM
XXS/1	63-75
XS/2	75-83
S/3	83-91
M/4	91-99
L/5	99-107
XL/6	107-115
XXL/7	115-123

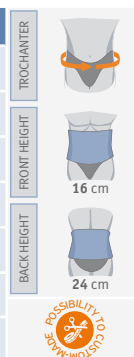

Characteristics:

Elastic fabric, rear molded stays covered with imitation leather, Velcro fastening.

Indications:

- Lumbago.
- Lumbosciatica.
- Degenerative processes.
- Weak and atonic muscles.
- Pre- and post-surgical treatment.

Colours:

LT-284: Beige.
LTB-284: White.
LTN-284: Black.



Ref.: **LT-303**

F .. C ... S ... I ..

REINFORCED UNIVERSAL LUMBAR BACK SUPPORT

SIZES	PERIMETER CM
1	75-91
2	91-115

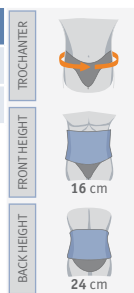

Characteristics:

Breathable multi-band material, 8 rear steel malleable stays, front velcro fastening. With elastic reinforcements to increase front to back compression.

Indications:

- Lumbago.
- Lumbosciatica.
- Muscular weakness.
- Degenerative processes.
- Disc hernia.
- Spondylolysis.
- Spondylarthrosis.

Colour: Beige.



Ref.: **LT-304**
BEIGE

Ref.: **LTB-304**
WHITE

Ref.: **LTN-304**
BLACK

F .. C ... S ... I ..

REINFORCED LUMBAR BACK SUPPORT "LUMBITRON STABLE FORTE"

SIZES	PERIMETER CM
XXS/1	63-75
XS/2	75-83
S/3	83-91
M/4	91-99
L/5	99-107
XL/6	107-115
XXL/7	115-123



Characteristics:

Elastic fabric, rear stays covered with imitation leather, lateral reinforcements, Velcro fastening.

Indications:

- Lumbago.
- Lumbosciatica.
- Degenerative processes.
- Weak and atonic muscles.
- Pre- and post-surgical treatment.

Colours:

LT-304: Beige.
LTB-304: White.
LTN-304: Black.





Ref.: FX-211



Ref.: FX-212



Ref.: FX-211 F ... C ... S ... I ...

SEMI-RIGID LUMBAR BACK SUPPORT WITH VELCRO FASTENINGS

Ref.: FX-212 F ... C ... S ... I ...

HIGH SEMI-RIGID LUMBAR BACK SUPPORT WITH VELCRO FASTENING

SIZES	PERIMETER CM	TROCHANTER	FRONT HEIGHT	BACK HEIGHT
S/1	85-95		20 cm (FX-211) 25 cm (FX-212)	27 cm (FX-211) 32 cm (FX-212)
M/2	95-105			
L/3	105-115			
XL/4	115-125			
XXL/5	125-135			

Characteristics:
Semi-rigid lumbosacral support made in semi-elastic cotton-rich fabric, easily adaptable rear anatomical stays, force-multiplier system by traction and adjustment straps and Velcro fastenings.

Indications:

- Lumbalgia and degenerative processes.
- Weak and atonic muscles.
- Disc hernias.
- Postoperative care.
- The fastening system allows multiplication of the traction force and facilitates adjustment and positioning with the minimum effort.

Colour: Beige.

Ref.: FX-213 F ... C ... S ... I ...

SEMI-RIGID DORSO-LUMBAR BACK SUPPORT WITH VELCRO FASTENING

SIZES	PERIMETER CM	TROCHANTER	FRONT HEIGHT	BACK HEIGHT
S/1	85-95			23 cm
M/2	95-105			
L/3	105-115			
XL/4	115-125			51 cm
XXL/5	125-135			

Characteristics:
Lumbodorsal support made in semi-elastic fabric with anatomic rear stays, force multiplier system by traction and adjustment straps, Velcro fastening.

Indications:

- Dorsalgia and degenerative processes.
- Weak and atonic muscles.
- Disc hernias.
- Postoperative care.
- The fastening system allows multiplication of the traction force and facilitates adjustment and placement with minimum effort.

Colour: Beige.





FASTENING SYSTEM

Refs: J001/J002 - Ref: J003/J004 incorporate a hidden trigger which frees and then opens the fastening system, avoiding involuntary opening due to any impact or friction on the fastening system.

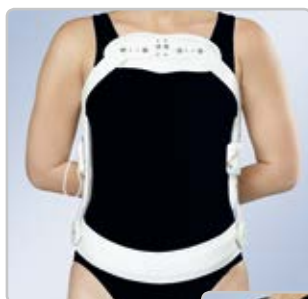

Ref.: J001A

Ref.: J002A



Ref.: J001 Ref.: J002 SHORT

F ... C · S I ...

JEWETT FRAME

Ref.: J001A Ref.: J002A SHORT

ARTICULATED JEWETT BRACE

Ref.: J001 / J001A

SIZES	PELVIC GIRTH	HEIGHT*
S/1	60-75	39-46
M/2	75-90	42-49
L/3	90-105	45-52
XL/4	105-115	49-56

*Between the sternal pad and the lower part of the pelvic strap.

Ref.: J002 / J002 A

SIZES	PELVIC GIRTH	HEIGHT*
M/2	75-90	39'5-43'5
L/3	90-105	42-49
XL/4	105-115	45'5-52'5

*Between the sternal pad and the lower part of the pelvic strap.

Models available:

J001: Jewett Frame.
J001A: Articulated Jewett Frame
J002: Short Model.

Characteristics:

3 support points (pectoral, suprapubic, dorsal lumbar). Light aluminium structure. Mobile sternum plate. Height regulation at side control plate level. Dorsal lumbar tightening plate, adjustable via band and fastening system. Padded plates for greater comfort. The pelvic band can be fixed or rocking, to be adapted to different positions of the patient. A new model (J001A) has been designed with a system to regulate chest support inclination with five adjustable positions at 20° intervals.

Indications:

- Fractures due to crushing.
- Vertebral pain caused by secondary metastasis. Spondyloarthrosis associated or not with arthritic sclerosis.
- Lumbalgia, lumbosciatica, and chronic dorsalgia.
- Stable vertebral fractures of the lower dorsal column and the lumbar column.
- Mid-term immobilisation after intervertebral disc surgery.
- Post-surgical care after spine surgery by decompression with or without internal attachment.

Colour: White.

Ref.: J003 Ref.: J004 SHORT

F ... C · S I ...

JEWETT FRAME WITH PUBIC SUPPORT

Ref.: J003

SIZES	PELVIC GIRTH	HEIGHT*
S/1	60-75	39-46
M/2	75-90	42-49
L/3	90-105	45-52
XL/4	105-115	49-56

*Between the sternal pad and the lower part of the pubic support.

Ref.: J004

SIZES	PELVIC GIRTH	HEIGHT*
M/2	75-90	39'5-43'5
L/3	90-105	42-49
XL/4	105-115	45'5-52'5

*Between the sternal pad and the lower part of the pubic support.

Characteristics:

3 support points (pectoral, suprapubic, dorsal lumbar). Light aluminium structure. Mobile sternum plate. Height regulation at side control plate level. Dorsal lumbar tightening plate, adjustable via band and fastening system. Padded plates for greater comfort with pubic support. The new locking system, with the buckle being fastened from back to front, easing the tension on the rear strap, making it easier to secure. There is a small hidden catch to release and open the lock, thereby preventing it from opening accidentally after a blow or after rubbing on the closure system.

Colour: White.

Models available:

J003: Jewett Frame.
J004: Short Model.

ACCESSORIES



Ref.: J100

JEWETT CHEST SUPPORT UNIT

SIZES

ONE SIZE

Features:

Consists of 2 individual padded supports linked to an adjustment strap to change the height and rotation.

Indications:

Sternal support intolerance due to respiratory failure, pigeon chest, sternum fractures, chest asymmetries and others.

Colour: White. / Units per pack: 2



Ref.: J101

JEWETT AXILLARY PROTECTOR

SIZES

ONE SIZE

Features:

Consists of 2 independent pads to prevent the frame irritating the underarm region.

Colour: White. / Units per pack: 2

F ... C ... S ... I ...



Ref.: LSO-B | Ref.: LSOC-B SHORT

LUMBOSACRAL RIGID CORSET

REFERENCE	VERSION	BACK HEIGHT	FRONT HEIGHT
LSO-B	UNISEX	39 cm	2(S)= 26 3(M)= 27 4(L)= 27 5(XL)= 28,5
LSOC-B	UNISEX	28,5 cm	2(S)= 17 3(M)= 18 4(L)= 18 5(XL)= 18,5

SIZES	PERIMETER CM
2(S)	80-90
3(M)	90-100
4(L)	100-110
5(XL)	110-120



Plates: Made in low density polyethylene that easily shapes itself to the dorsal curves, the thermomoldable plates can be shaped by an orthopaedic technician using a hot air gun.

Characteristics: Twin shell corset formed by a front plate, a back plate with overlap areas on the side, all in thermoplastic and with strong lateral shaped stays. They are covered with strong external material and smooth internal ribbed fabric. The areas are joined together by a side zip and adjustable front-to-back straps, with distal zones of greater surface area and a small hook to attach to the front plate padding.

- Indications:**
- Disc hernias.
 - Osteoporosis.
 - Spondyloarthrosis.
 - Spondylolysis with or without slip.
 - Traumatism.
 - Compression fractures.
 - Degenerative disc disease.
 - Postoperative fusion.
 - Chronic muscular disease.
 - Treatment of vertebral metastasis.
 - The LSO-C model is especially indicated in patients who spend the majority of the time lying down.

Colour: Beige.
Models available:
LSO-B: Lumbosacral orthosis.
LSOC-B: Short lumbosacral orthosis.

F ... C ... S ... I ...



Ref.: TL50-B

THORACIC LUMBOSACRAL RIGID CORSET

REFERENCE	VERSION	BACK HEIGHT	FRONT HEIGHT
TL50-B	UNISEX	51 cm	2(S)= 26 3(M)= 27 4(L)= 27 5(XL)= 28,5

SIZES	PERIMETER CM
2(S)	80-90
3(M)	90-100
4(L)	100-110
5(XL)	110-120



Plates: Made in low density polyethylene that easily shapes itself to the dorsal curves, the thermomoldable plates can be shaped by an orthopaedic technician using a hot air gun.

Characteristics: The TL50 model has padded shoulder straps that force the shoulders upwards avoiding discomfort under the arms when attaching the guide straps. The distal ends of the straps have a small hook and can be adjusted to the height and width of the patient.

- Indications:**
- Disc hernias.
 - Osteoporosis.
 - Spondyloarthrosis.
 - Spondylolysis with or without slip.
 - Traumatism.
 - Compression fractures.
 - Degenerative disc disease.
 - Postoperative fusion.
 - Chronic muscular disease.
 - Treatment of vertebral metastasis.

Colour: Beige.



Ref.: SD100 | Ref.: SD101 HIGH

F ... C ... S ... I ...

STAR BRACE® DYNAMIC SEMI-RIGID BACK SUPPORT

SIZES	PERIMETER CM	TROCHANTER
S/1	75-85	
M/2	85-95	
L/3	95-110	18 cm (SD100) 23 cm (SD101)
XL/4	110-125	27 cm (SD100) 32 cm (SD101)

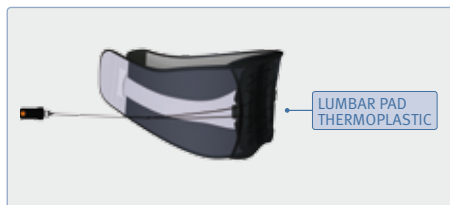

Characteristics:

The Dynamic Star Brace back support is a semi-rigid lumbosacral orthosis made of a breathable bilayer material of Velour in polyamide and Poromax lining. This facilitates ventilation and moisture absorption, while also incorporating a unique antibacterial Thermo-tex treatment to prevent the growth of bacteria causing unpleasant smells. The lumbar area contains a thermoplastic stay within its inner padding while on the outside there is a thermoplastic frame with a string pulley system.

Indications:

- Lumbago, sciatica, degenerative conditions, atony and muscular weakness, pre- and post-surgical treatments, herniated disc, spondylarthritis, spondylolysis.
- Firm lumbosacral support, fits perfectly to the body, comfortable for daily use.

Colour:

Grey.

Models available:

- SD100: Short Semi-Rigid Back Support.
- SD101: High Semi-Rigid Back Support.

Components:



Back support

+



Thermoplastic pad



PULLEY TRACTION SYSTEM

“Compression and limitation of lumbosacral mobility” adjustable via the pulley control system.

STAR BRACE® DYNAMIC AND STAR BRACE® DYNAMIC FIX ACCESSORIES



Ref.: SD115

STAR BRACE® DYNAMIC THERMOPLASTIC PLATE FOR PENDULOUS ABDOMENS

Characteristics:

As a replacement for the abdominal plates in Star Brace® Dynamic and Dynamic fix orthoses for use by patients with pendulous abdomens to ensure a more comfortable fit. Ref. SD115 is specially designed for patients with these morphological characteristics

Colour:

Black.

SIZES ONE SIZE

F C S I

Ref.: SD103 | Ref.: SD104 HIGH

STAR BRACE® DYNAMIC FIX SEMI-RIGID CORSET



SIZES	PERIMETER CM	TROCHANTER	FRONT HEIGHT	BACK HEIGHT
S/1	75-85		18 cm (SD103) 23 cm (SD104)	30 cm (SD103) 38 cm (SD104)
M/2	85-95			
L/3	95-110			
XL/4	110-125			

Characteristics:

The Dynamic Fix Star Brace Dynamic Fix/corset is a rigid lumbosacral orthosis made of a breathable bilayer material of Velour in polyamide and Poromax lining. The lumbar area contains a moulded, low-density polyethylene thermoplastic module within its inner padding, which is attached via a textile cover that allows the module to be removed. There is also an abdominal compression plate incorporated. Contains a hook closure system. In addition, the module can be removed from the Dynamic Fix Star Brace Dynamic Fix/corset to leave a semi-rigid back support.

Indications:

- Herniated discs, osteoporosis, spondyloarthritis, spondylolysis with or without stability, trauma, compression fractures, degenerative disc disease, post-operative fusion, chronic muscle illness, treatment of vertebral metastasis.

Colour:

■ Grey.

Models available:

SD103: Short Semi-Rigid Corset.
SD104: High Semi-Rigid Corset.

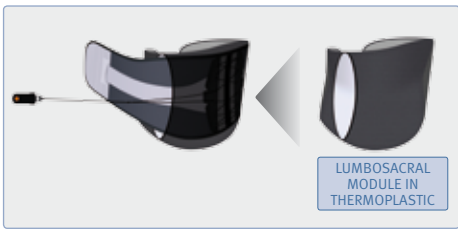

Components:



MAIN FEATURES

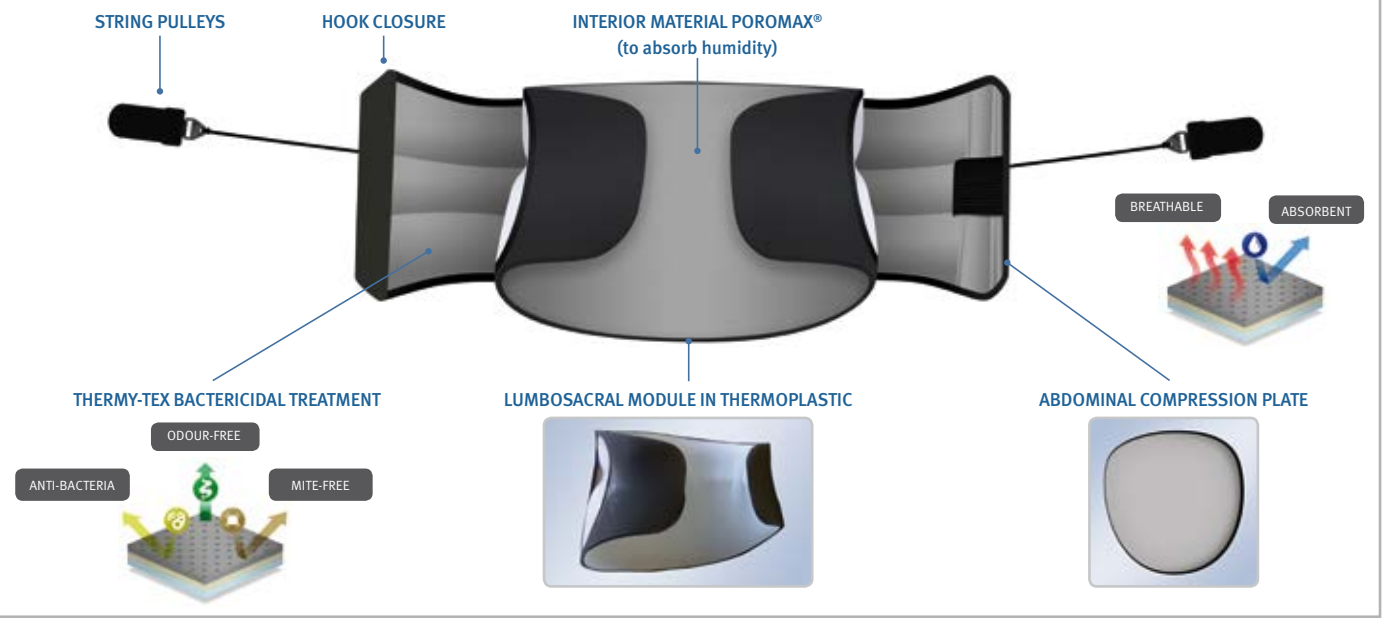

REPLACEMENTS PARTS FOR STAR BRACE® DYNAMIC AND STAR BRACE® DYNAMIC FIX

 Ref.: SD110 THERMOPLASTIC LUMBOSACRAL MODULE For model SD103 SIZES: S/1, M/2, L/3, XL/4 For braces of the same size. Height 30 cm.	 Ref.: SD111 WIDE THERMOPLASTIC LUMBOSACRAL MODULE For model SD104 SIZES: S/1, M/2, L/3, XL/4 For braces of the same size. Height 38 cm.	 Ref.: SD112 ABDOMINAL COMPRESSION PLATE SIZES: ONE SIZE	 Ref.: SD113 THERMOPLASTIC PAD Size 1 for model SD100 / Size 2 for model SD101 SIZES: 1, 2 HEIGHT: 27 cm, 32 cm
--	---	--	---



Ref.: **KC201** BEIGE

Ref.: **KC101** GREY

Ref.: **KC200A** ABDOMEN PENDULUM

KNIGHT CORSET

F •••• C •••• S •••• I ••••

Characteristics:

Lumbar sacral orthosis made from breathable honeycomb fabric and terrycloth. Its interior consists of a rigid structure of malleable aluminium and transversal stays to enable adjustment of lumbar lordosis if necessary. The front section is elasticated to enable the abdominal pressure to be adjusted to the physical characteristics of each patient. Closure is by means of a Velcro system located at the front. Patients with prominent abdomens are recommended to use the pendulous abdomen model to ensure greater comfort.

Indications:

• Indicated for patients with lumbosacral injuries requiring immobilisation of this area of the spine to enable treatment, such as vertebral wedging, lumbar trauma, hernias, postoperative care, osteoporosis and vertebral fractures. Lumbago requiring temporary immobilisation.

Colour:

Ref.: KC201: ■ Beige.

Ref.: KC101: ■ Grey.

Ref.: KC200A: ■ Beige.

Ref.: KC201 / KC101

SIZES	PERIMETER CM	TROCHANTER	FRONT HEIGHT	BACK HEIGHT
S/2	80-90			
M/3	90-100		20 cm	
L/4	100-110			32 cm
XL/5	110-120			

Ref.: KC200A

SIZES	PERIMETER CM	TROCHANTER	FRONT HEIGHT	BACK HEIGHT
S/2	90-100			
M/3	100-110		25 cm	
L/4	110-120			28 cm
XL/5	120-130			



Modular dorso-lumbar Taylor orthosis ▶ Lumbar Sacral Orthosis



Ref.: TC101 GREY

Ref.: TC201 BEIGE

Ref.: TC200A ABDOMEN PENDULUM

MODULAR DORSO-LUMBAR TAYLOR ORTHOSIS



Characteristics:

The lumbar and dorsal elements are made from breathable honeycomb fabric with terrycloth interior. The dorsal element features preformed malleable aluminium splints and adjustable semi-elastic straps in a soft padded fabric to fit the underarm area and achieve optimum comfort. The lumbosacral element features a belt with a lumbar structure and rear stays.

On their inner edge, from where they start on the dorsal side up to the shoulders, the straps are made with a more rigid edging to ensure a better fit for the dorsal element, thus enabling greater elasticity in the underarm area.

Indications:

- Especially indicated in cases of kyphosis, vertebral wedging, dorso-lumbar injuries, infectious diseases that affect the dorsal spine, spinal disc herniation, post-operative care, osteoporosis, vertebral fractures and in all cases in which correction of kyphotic curvature is required.
- Certain low lumbago-associated dorsalgia (T8, T12) that requires temporary immobilisation (patient journeys, mechanical, work-related and domestic stresses and strains, etc.). In cases where partial thoracic containment is required at certain times of the day depending on the activity.
- A model is available for patients with pendulous abdomens (Ref.:TC200A).

Colour:

- Ref.: TC201: ■ Beige.
- Ref.: TC101: ■ Grey.
- Ref.: TC200A: ■ Beige.

Ref.: TC201 / TC101

SIZES	PERIMETER CM	TROCHANTER	FRONT-HEIGHT	BACK-HEIGHT
S/2	80-90			
M/3	90-100		20 cm	
L/4	100-110			47 cm min. 60 cm max.
XL/5	110-120			

Ref.: TC200A

SIZES	PERIMETER CM	TROCHANTER	FRONT-HEIGHT	BACK-HEIGHT
S/2	90-100			
M/3	100-110		25 cm	
L/4	110-120			47 cm min. 55 cm max.
XL/5	120-130			

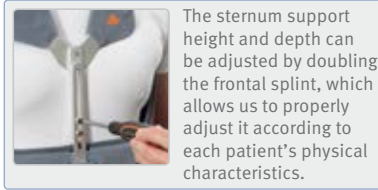

The sternum support height and depth can be adjusted by doubling the frontal splint, which allows us to properly adjust it according to each patient's physical characteristics.



Ref.: CT1001
MAN

Ref.: CT1002
WOMAN

F ... C ... S ... I ...

TWIN SHELL CORSET

MAN	HIP	WAIST	BELOW CHEST
XS/1	71-81	51-71	66-78
S/2	81-91	71-81	78-90
M/3	91-101	81-91	90-102
L/4	101-114	91-101	102-114
XL/5	114-127	101-114	114-128

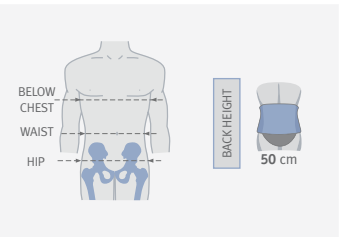

WOMAN	HIP	WAIST	BELOW CHEST
XS/1	71-81	46-56	58-68
S/2	81-91	56-66	68-78
M/3	91-101	66-76	78-88
L/4	101-114	76-86	88-98
XL/5	114-127	86-96	98-108

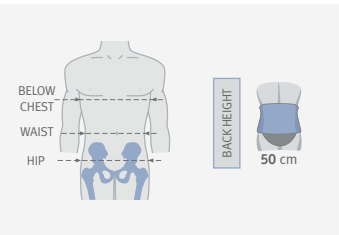

Characteristics:

Thoracolumbosacral corset made of 4 mm low-density polyethylene and lined with a padded fabric that can be easily removed, allowing it to be washed and thus achieving proper hygiene of the orthosis while simultaneously protecting the patient from possible chafing. A padded, height-adjustable splint is located on the front section, allowing us to achieve a complete extension of the spinal column. Polyethylene is a thermo-moldable material, allowing us to make adjustments on the corset by applying heat (the fabric lining must be removed before applying heat). The frontal plane is located from the sternum to the pubic symphysis; the breast area remains free on women. The rear plane is located from the middle third of the scapula to the halfway point of the gluteus region.

The Orliman twin shell corset features 15° of lumbar lordosis.

It is fastened with dobbies and Velcro straps at the iliac crests, waist, and underarms.

The sternum support height and depth can be adjusted by doubling the frontal splint, which allows us to properly adjust it according to each patient's physical characteristics. One of the main advantages of its design is that it facilitates placement on bedridden patients.

Indications:

- Conditions that require immobilization of the spinal or lumbar areas, such as pre and post-op spinal procedures.
- Vertebral fractures.
- Herniated disc.
- Osteoporosis.
- Spondylolysis, spondylolisthesis, spondyloarthropathy, painful scoliosis in adults, etc.
- Torn or lax ligaments.
- Neoplasia that causes degenerative processes in the spine.
- Thoracic Kyphosis in mid to lower spinal region.
- Prevention of spinal stenosis in bedridden patients.

Colour: Grey.



Back Support Belts



Ref.: L-250

F ... C ... S ... I ...

"CLASSIC" ELASTIC LUMBAR BACK SUPPORT



SIZES	PERIMETER CM
XS/1	75-83
S/2	83-91
M/3	91-99
L/4	99-107
XL/5	107-115
XXL/6	115-125
XXXL/7	123-131



Characteristics:

Back support made with highly resistant and hardwearing fabric. Rear crossed bands and flexible strips. Front Velcro fastening.

Indications:

- Lumbar symptoms.
- Lumbago. Lumbosciatica.
- Weak and atonic muscles.
- Degenerative processes.
- Prophylaxis of the lumbar region.
- Containment.
- Support and specific adjustment to the anatomy.

Colour: Beige.

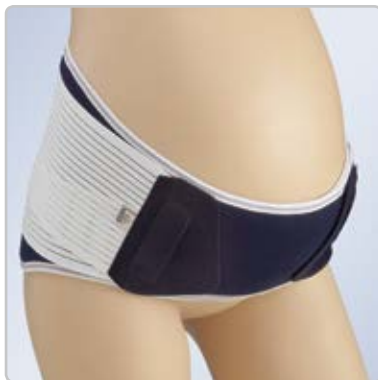

Ref.: A-131

F ... C ... S ... I ...

PREGNANCY BACK SUPPORT

SIZES	PERIMETER CM
S/1	80-105
M/2	106-122
L/3	123-140



Characteristics:

Short sacrolumbar back brace manufactured in multiband, transpirable, elastic material, incorporating flexible rear stays. Elastic lateral bands for the regulation of the compression with micro-velcro fastening on velour material and finger hooks for easier fitting.

Indications:

- To relieve lumbago during pregnancy.
- Mechanical effect: the regulation of the compression contributes to the control of the hyperlordosis normally found in pregnant women during the last months of pregnancy.

Colour: White.



Ref.: A-132

F ... C ... S ... I ...

EVENTRATION BACK SUPPORT

SIZES	PERIMETER CM
S/1	70-90
M/2	90-110
L/3	110-130



Characteristics:

Lumbosacral belt for eventrations, manufactured in multiband material, with posterior stays and velcro fastening.

Indications:

- The eventration belt provides a general compression in the abdominal zone, due to its selective compression belt which helps to avoid the appearance of abdominal eventrations, or gives support to an existing eventration.

Colour: White.



Ref.: CEN-410

F ... C ... S ... I ...

LUMBAR BACK SUPPORT

SIZES	PERIMETER CM
S/1	70-85
M/2	85-100
L/3	100-115
XL/4	115-125



Characteristics:

Lumbosacral support belt with a strong combination of elastic and cotton fabric, four semi-rigid steel rear stays and front Velcro fastening.

Indications:

- Lumbalgia.
- Lumbosciatica.
- Work or sport-related overexertion.
- Strong support, containment and adjustment.
- Can be worn over clothing.

Colour: Black.

Back Support Belts



Ref.: T-420

F ... C ... S ... I ...

WORK PROTECTION BACK SUPPORT

SIZES	PERIMETER CM
S/1	73-85
M/2	85-97
L/3	97-110
XL/4	110-125

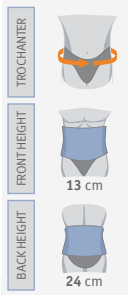

Characteristics:

Elastic back support made of breathable lycra with four rear stays, interior silicone points inside to prevent slipping, adjustable tension elastic bands, double fastening system and interchangeable adjustable straps.

Indications:

- Lumbar symptoms.
- Work-related prophylaxis.
- Prevention of back injuries.

Colour: Black.



Ref.: T-421

F ... C ... S ... I ...

HIGH CONTAINMENT WORK PROTECTION BACK SUPPORT

SIZES	PERIMETER CM
S/2	75-90
M/3	90-105
L/4	105-125

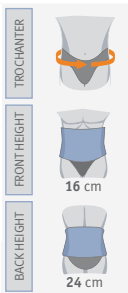

Characteristics:

Elastic back support with four rear stays, adjustable tension elastic bands, double fastening system and interchangeable adjustable straps.

Indications:

- Lumbar symptoms.
- Work-related prophylaxis.
- Prevention of back injuries.

Colour: Black.



Back Support Belts



Ref.: BE-160
(MEN) **Ref.: BE-170**
(WOMEN)

F .. C .. S .. I ..

RIB BANDS

SIZES	PERIMETER CM	BELOW CHEST	FRONT HEIGHT	BACK HEIGHT
XXS/1	75-83			
S/2	83-91			
M/3	91-99			
L/4	99-107			
XL/5	107-115			
XL/6	115-125			

POSSIBILITY TO CUSTOMIZE WOMEN

- Characteristics:** Breathable multi-band elastic band with velcro fastening. (Low-cut in BE-170 model to free breasts).
- Indications:**
 - Rib syndromes.
 - Thoracic post-surgery.
 - Containment and support.
 - Very comfortable and easy to use.
- Colour:** Beige.



Ref.: BE-165
(MEN) **Ref.: BE-175**
(WOMEN)

F ... C ... S .. I ..

RIB BANDS

SIZES	PERIMETER CM	BELOW CHEST	FRONT HEIGHT	BACK HEIGHT
S/1	70-90			
M/2	90-110			
L/3	110-130			
SIZES WOMEN BE-175				
ONE SIZE				

- Characteristics:** One-piece elastic band with Velcro fastening.
- Indications:**
 - Rib syndromes.
 - Thoracic post-surgery.
 - Containment and support.
 - Very comfortable and easy to use.
- Colour:** Beige.

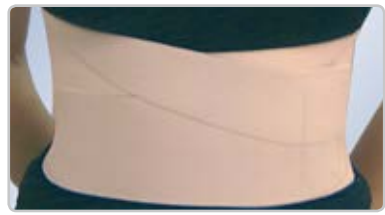

Ref.: BE-245

F ... C ... S .. I ..

THREE BAND SUPPORT

SIZES	PERIMETER CM	ABDOMEN	FRONT HEIGHT	BACK HEIGHT
S/1	70-90			
M/2	90-110			
L/3	110-130			

- Characteristics:** One-piece elastic band with Velcro fastening.
- Indications:**
 - Lumbar containment of small and medium eventrations.
 - Post-surgical and post-natal containment support.
 - Containment and support.
 - Very comfortable and easy to use.
- Colour:** Beige.



Ref.: BE-305

F ... C ... S .. I ..

FOUR BAND SUPPORT

SIZES	PERIMETER CM	ABDOMEN	FRONT HEIGHT	BACK HEIGHT
S/1	70-90			
M/2	90-110			
L/3	110-130			

- Characteristics:** One-piece elastic band with Velcro fastening.
- Indications:**
 - Containment of small and medium eventrations.
 - Post-surgical and post-natal containment support.
 - Lumbar containment and support.
 - Comfortable and easy to use.
- Colour:** Beige.

Back Support Belts



BEB-240



BE-240 / BE-300

Ref.: BEB-240 Ref.: BE-240
Ref.: BE-300

F .. C .. S . I .

ELASTIC ABDOMINAL BAND

SIZES	PERIMETER CM	ABDOMEN
XXS/1	75-83	
S/2	83-91	FRONT HEIGHT
M/3	91-99	24 cm (BE-240) 30 cm (BE-300)
L/4	99-107	BACK HEIGHT
XL/5	107-115	24 cm (BE-240) 30 cm (BE-300)
XL/6	115-125	

Characteristics:

Band made with breathable multi-band elastic fabric. Cushioned abdominal area.

Indications:

- Containment of small and medium eventrations.
- Post-surgical and post-natal containment band.
- Lumbar containment and support.
- Easy to use and comfortable.

Colour:

BEB-240: White.
BE-240 / BE-300: Beige.



Ref.: BE-240 A

F .. C .. S . I .

ELASTIC ABDOMINAL PENDULUM BAND

SIZES	PERIMETER CM	ABDOMEN
3	91-99	
4	99-107	FRONT HEIGHT
5	107-115	24 cm
6	115-125	BACK HEIGHT
7	125-135	24 cm
8	135-146	

Characteristics:

Band made with breathable multi-band elastic fabric. Cushioned abdominal area.

Indications:

- Containment of small and medium eventrations.
- Post-surgical and post-natal containment band.
- Lumbar containment and support.
- Easy to use and comfortable.

Colour:

Beige.



Ref.: BE-280

F ... C ... S .. I ..

ELASTIC ABDOMINAL BAND



SIZES	PERIMETER CM	ABDOMEN
S/1	70-90	
M/2	90-110	FRONT HEIGHT
L/3	110-130	28 cm

Characteristics:

A one-piece abdominal band manufactured in a cotton stretch fabric, providing comfortable contact with the patient's skin. Its design and elasticity enables optimum adaptation to the waist or pelvis. Its fastening system, featuring a large Velcro area, enables it to be fitted and attached to the entire abdominal wall.

Indications:

- Lumbar containment of small and medium eventrations.
- Post-surgical and post-natal containment support.

Colour:

Beige.



Stomamed®

Abdominal Supports For Ostomy Patients



Includes a reinforcement plate for get a better containment.

Ref.: COL-245/COL-247/COL-249 (24 cm)

Ref.: COL-165/COL-167/COL-169 (16 cm)

F ... C ... S . I .

ABDOMINAL SUPPORT FOR OSTOMY PATIENTS WITH ORIFICE

SIZES	PERIMETER CM	ABDOMEN	FRONT HEIGHT	BACK HEIGHT
XS/1	75-85			
S/2	85-95		16 cm	
M/3	95-105			24 cm
L/4	105-120			



REFERENCE	HEIGHT CM	Ø STOMA MM
COL-245	24	50
COL-247	24	75
COL-249	24	90
COL-165	16	50
COL-167	16	75
COL-169	16	90

Opening located 4 cm from lower edge.

Characteristics:

Abdominal support made with elastic fabric joined to a rigid and non-malleable piece for greater containment of the stoma region. It has 8 flexible stays that avoid the velt from ruching up.

Indications:

- Post-operative care in colostomies and ileostomies.
- Abdominal containment, mainly in the area of the stoma.

Colour: ■ Beige.

Components:

Includes a band to cover bag.
A reinforcement plate.



Components:

- A band to cover bag.
- Reinforcement plate.
- Edging and measurement tables (50-75-90 mm).

Ref.: COL-240 (24 cm)

Ref.: COL-160 (16 cm)

F ... C ... S . I .

ABDOMINAL SUPPORT FOR OSTOMY PATIENTS WITHOUT ORIFICE

SIZES	PERIMETER CM	ABDOMEN	FRONT HEIGHT	BACK HEIGHT
XS/1	75-85			
S/2	85-95		16 cm	
M/3	95-105			24 cm
L/4	105-120			

REFERENCE	HEIGHT CM
COL-240	24
COL-160	16

Characteristics:

Abdominal support made with multi-band elastic fabric joined to a rigid and non-malleable piece for greater containment of the stoma region. It has 8 flexible stays that avoid the velt from ruching up.

Indications:

- Post-operative care in colostomies and ileostomies.
- Abdominal containment, mainly in the area of the stoma.

Colour: ■ Beige.

MAIN FEATURES



Sacroiliac compression pad



Drive system for pulleys



Regulation of the compression at will

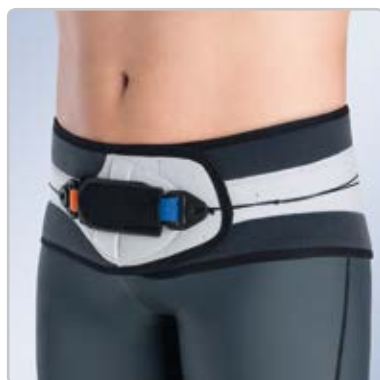

Ref.: SD102

F ... C ... S ... I ...

SACROILIAC BELT

SIZES	PERIMETER CM	TROCHANTER	FRONT HEIGHT	BACK HEIGHT
S/1	70-80			
M/2	80-95		11 cm	17 cm
L/3	95-110			
XL/4	110-125			

Characteristics:

A 17-cm wide pelvic belt made from velour and Poromax fabric, supplied with a sacroiliac pad made from foam and a hook closure system. Compression adjustment system by means of pulleys to enable maximum compression with the minimum of effort.

Indications:

- Sacroiliac joint injuries with or without inflammation.
- Sacroiliac joint sprain.
- Sacroiliac joint instability.
- Dynamic osteopathy of pubis (groin injury), trauma injuries to the pubic symphysis.

Colour: Grey.

Function:

Compression and stabilisation of the sacroiliac joint to suppress ligament-muscle reflexes and reduce muscle spasm in the back. It enables unrestricted freedom of movement, as it is more comfortable and smaller than conventional belts.

Shoulder Supports

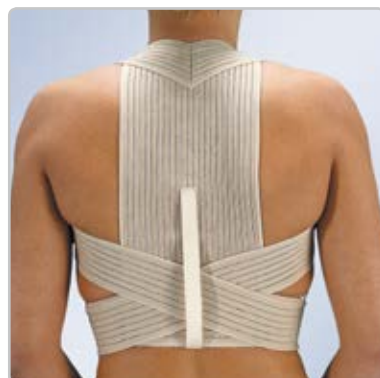
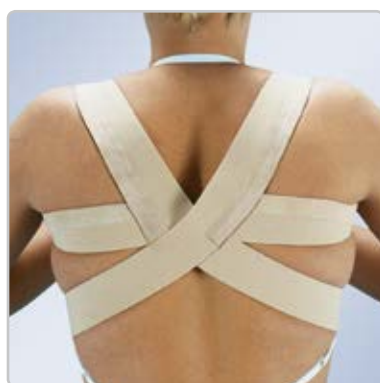

Ref.: E-240

F .. C . S .. I ..

STRONG SHOULDER SUPPORT

SIZES	PERIMETER CM	BELOW CHEST
XS/1	75-85	
S/2	80-92	
M/3	85-97	
L/4	92-104	
XL/5	98-110	
XXL/6	104-120	

Characteristics:

Includes two cotton elastic fabric, ring bands, independent for each shoulders. The ends of the bands exert gradual traction, achieving retropulsion of the shoulders and correcting poor kyphotic posture.

Indications:

- Dorsalgia.
- As corrector of incorrect positions and poor posture.
- It is not recommended for use more than 3-4 hours per day.

Colour: Beige.

Ref.: ET-210

F .. C . S .. I ..

BREATHABLE SHOULDER SUPPORT

SIZES	PERIMETER CM	BELOW CHEST
XS/1	75-85	
S/2	80-92	
M/3	85-97	
L/4	92-104	
XL/5	98-110	
XXL/6	104-120	

Characteristics:

Wide dorsal band of breathable multi-band elastic fabric. Two upper bands are lengthened over the shoulders, pass under the arm, cross the back and fasten over the abdomen permitting gradual traction of the back through retropulsion of the shoulders until the poor kyphotic posture is corrected.

Indications:

- Dorsalgia.
- As corrector of incorrect positions and poor posture.
- Regulation of the dorsal position by postural effects and anatomic recall.
- It is not recommended for use more than 3-4 hours per day.

Colour: Beige.



Ref.: 0-104

F ... C ... S . I .

NAVEL TRUSS

SIZES	PERIMETER CM
7	73-83
8	84-91
9	92-99
10	100-107
11	108-120

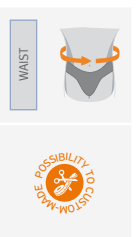

- Characteristics:** Elastic strap with rear Velcro fastening and interchangeable navel cushion.
- Indications:**
 - Reduction of umbilical hernias.
 - Good compression on the navel area.
- Colour:** Beige.



Ref.: B-110/D-111/I-112

F ... C ... S . I .

REINFORCED TRUSS WITH VELCRO FASTENING

SIZES	PERIMETER CM
7	70-78
8	78-86
9	86-94
10	94-102
11	102-110
12	110-120

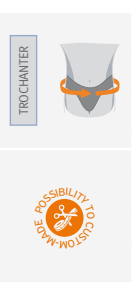

- Characteristics:** Elastic belt with Velcro fastening, anatomic cushions extended with straps under the buttocks and fixed to the sides.
- Indications:**
 - Lateral reducible inguinal hernias (right or left) and bilateral (right and left).
 - Compression and reduction of hernias, maximum containment and comfort.
- Colour:** Beige.
- Models available:**
 - B-110: Bilateral.
 - D-111: Right.
 - I-112: Left.



Ref.: BH-110/DH-111/IH-112

F ... C ... S . I .

REINFORCED TRUSS WITH BUCKLE FASTENING

SIZES	PERIMETER CM
7	70-78
8	78-86
9	86-94
10	94-102
11	102-110
12	110-120

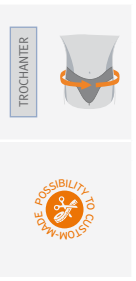

- Characteristics:** Elastic belt with buckle fastening, larger anatomic cushions than those of the truss with Velcro fastening, extended with straps under the buttocks and fixed to the sides.
- Indications:**
 - Lateral reducible inguinal hernias (right or left) and bilateral (right and left)
 - Compression and reduction of hernias, maximum containment and comfort.
- Colour:** Beige.
- Models available:**
 - BH-110: Bilateral.
 - DH-111: Right.
 - IH-112: Left.



Ref.: BS-110

Ref.: BB-100 BAG

F ... C ... S . I .

SUSPENSORY TRUSS

REF: BB-100

SIZES	LENGTH (CM) BETWEEN A-C-B
1	25
2	27
3	29
4	31
5	33
6	35
7	37

REF: BS-110

SIZES	PERIMETER TROCHANTER CM
7	70-80
8	78-86
9	86-94
10	94-102
11	102-110
12	110-120

- Characteristics:** Truss with double elastic belt, straps under the buttocks with fastening on the side and interchangeable scrotal bag.
- Indications:**
 - In large scrotal hernias.
- Colour:** Beige.
- Models available:**
 - BS-110: Truss belt.
 - BB-100: interchangeable scrotal bag.

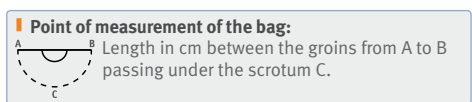



S-120



S-121

Ref.: S-120 MAN

Ref.: S-121 WOMAN

F ... C ... S . I .

HERNIA SLIP

SIZES
75
80
85
90
95
100
105
110
120



Characteristics:

Slip made with fabric of varying elasticity at different points, two types of cushion, scrotal band holds the abdomen with Velcro fastening, easy placement and washing. Male and female versions.

Indications:

- Inguinal hernias.
- Especially recommended in pre- and post-surgical processes.
- Uniform containment of the inguinal area.

Colour: ■ Beige.

Models available:

- S-120: Man
- S-121: Woman.



BACK INCLINATION OF THE PELVIS



Posture not corrected.



Improved positioning with the pelvic belt.



CAUSES

Issues related to wheelchairs:
 Seat too deep, back support too short and footrest too low/forward.
 Physical conditions:
 Tense hamstring tendons, atonic muscles and kyphosis.

OPTIONS FOR THE HIP BELT

The objective of the belt is to avoid slipping.

OBLIQUITY AND ROTATION OF THE PELVIS



Posture not corrected.



Improved positioning with the pelvic belt.

CAUSES

Issues related to wheelchairs:
 The covering of the chair is not fitted, the wheelchair is too wide and the seat is too short.
 Physical conditions:
 Irregular muscle tone in the torso, muscular imbalance and scoliosis.

OPTIONS FOR THE HIP BELT

The objective of the belt is to lower the pelvis and move it backwards in the seat system.



Ref: 1202

F ... **C** .. **S** .. **I** ...

BUCKLE FASTENER PELVIC BELT

SIZES	CM
XS/0 (child)	13-23
S/1	18-28
M/2	23-38
L/3	33-48



Measure the width of the hip between the greater trochanters with the person seated, considering other factors such as growth, weight variations and clothing.

Characteristics:

Made from padded neoprene, it has 2 straps which are joined with a buckle fastener. Both ends of the belt have 1 nylon dobby with a slide for length adjustment and a slide which is fastened using a screw.

Indications:

- Suitable for patients with good anterolateral control whilst seated but with a tendency to slide out of the seat.

Colour: Black.



TRUNK-JACKET HARNESS



Posture not corrected.



Improved positioning with the jacket harness.

The trunk is important for postural alignment and stability since it determines the position of the head and the upper extremities.

PERFECT POSTURE

- Neutral alignment of spine and head.
- Level shoulders.
- Shoulders slightly behind the pelvis.
- Neutral pelvis.
- Hyperextension of the spine.



Ref.: 1204

F ... C ... S ... I ...

TECHNICAL HARNESS JACKET WITH ZIP

SIZES	CM
XS/0 (child)	23-27
S/1	28-32
M/2	33-41
L/3	41-48



Measure the width of the back. If the measurement is between 2 sizes, take into account other factors such as growth, weight variations and clothing.

Characteristics:

Made from padded neoprene, the ends have fastening straps with a length adjustment system and a slide with an orifice on one end in order to fasten to a chair using a screw. The other end has a fastening button for quick adjustment both in release and in fastening. The central part has a zip for opening and closing.

Indications:

- Correct positioning increases patient functionality, particularly when seated in a mobility chair.
- The constant movements of the centre of gravity when the patient is mobilised in a wheelchair leads to instability, making it necessary to balance the skeleton.
- The correct combination of the seat back and front support allow us to apply the force necessary for correct posture and stability, using as parameters 100° for the hips, 105° for the knees and 90° for the ankles, whilst obtaining proper alignment of the vertebral column and head and levelling of the pelvis.

Colour: ● Black.

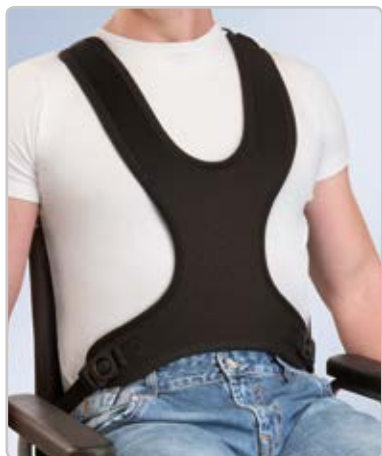

Ref.: 1205

F ... C ... S ... I ...

TECHNICAL HARNESS JACKET WITHOUT ZIP

SIZES	CM
XS/0 (child)	23-27
S/1	28-32
M/2	33-41
L/3	41-48



Measure the width of the back. If the measurement is between 2 sizes, take into account other factors such as growth, weight variations and clothing.

Characteristics:

Made from padded neoprene, the ends have fastening straps with a length adjustment system and a slide with an orifice on one end in order to fasten to a chair using a screw. The other end has a fastening button for quick adjustment both in release and in fastening.

Indications:

- Correct positioning increases patient functionality, particularly when seated in a mobility chair.
- The constant movements of the centre of gravity when the patient is mobilised in a wheelchair leads to instability, making it necessary to balance the skeleton.
- The correct combination of the seat back and front support allow us to apply the force necessary for correct posture and stability, using as parameters 100° for the hips, 105° for the knees and 90° for the ankles, whilst obtaining proper alignment of the vertebral column and head and levelling of the pelvis.

Colour: ● Black.

ACCESSORIES

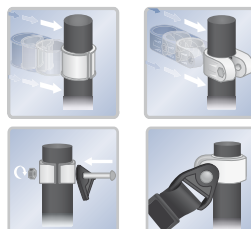
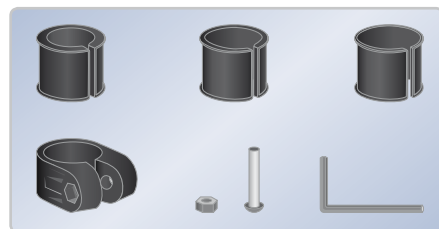

Ref.: 1104

CLAMPS KIT

SIZES ONE SIZE

Consists of:

- 2 clamps of 25 mm.
- 2 adapters of: 19-21-22 mm.
- 2 screw.
- 1 allen key.

Colour: ● Black.

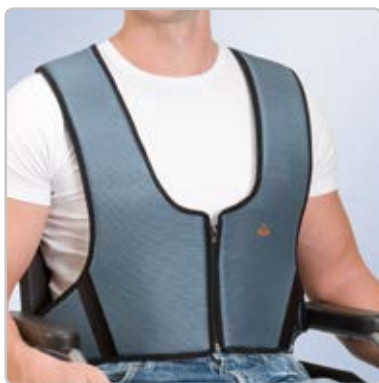

Ref.: 1000 F ... C .. S ... I ...

JACKET HARNESS WITH ZIP

SIZES	PERIMETER CM
XS/0	64-138
S/1	79-168
L/2	89-178

TOTAL CIRCUMFERENCE OF PERSON AND SEAT OR CHAIR

POSSIBILITY TO CUSTOM-MAKE

- Characteristics:** Made from a triple layer of breathable semi-rigid material (polyamide, foam and polyester), it has regulation and securement straps with colour-coded buckle fasteners to facilitate positioning. The pectoral zone has a zip to facilitate the positioning of the jacket harness, allowing for adaptation without undoing the securement straps.
- Indications:**
 - Suitable for patients with anterolateral instability, and can be adapted to wheelchairs and other types of chairs and seats, including car and other transport seats.
- Colour:** ■ Blue.

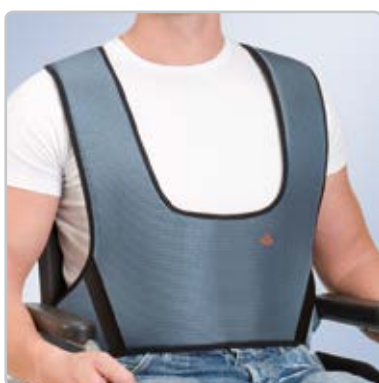

Ref.: 1001 F ... C .. S ... I ...

JACKET HARNESS

SIZES	PERIMETER CM
S/1	79-168
L/2	89-178

TOTAL CIRCUMFERENCE OF PERSON AND SEAT OR CHAIR

POSSIBILITY TO CUSTOM-MAKE

- Characteristics:** Made from a triple layer of breathable semi-rigid material (polyamide, foam and polyester), it has regulation and securement straps with colour-coded buckle fasteners to facilitate positioning.
- Indications:**
 - Suitable for patients with anterolateral instability, and can be adapted to wheelchairs and other types of chairs and seats, including car and other transport seats.
- Colour:** ■ Blue.

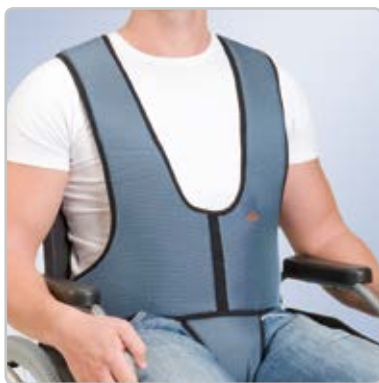

Ref.: 1002 F ... C .. S ... I ...

JACKET HARNESS WITH PERINEUM PIECE

SIZES	PERIMETER CM
S/1	79-168
L/2	89-178

TOTAL CIRCUMFERENCE OF PERSON AND SEAT OR CHAIR

POSSIBILITY TO CUSTOM-MAKE

- Characteristics:** Made from a triple layer of breathable semi-rigid material (polyamide, foam and polyester), it has regulation and securement straps with colour-coded buckle fasteners to facilitate positioning. It comprises an abdominal belt attached to a bib with shoulder pads and a perineum strap, and on the ends there is a nylon dobbie with a slide and a fastening system to regulate the required securement.
- Indications:**
 - Suitable for patients with anterolateral instability and a tendency to slide out of the seat, and can be adapted to wheelchairs and other types of chairs and seats, including car and other transport seats.
- Colour:** ■ Blue.



Ref.: 1003 F ... C .. S ... I ...

LEG ABDUCTOR HARNESS

SIZES	THIGH CIRCUMFERENCE CM
XS/0	27-37
S/1	60-75
L/2	65-80

POSSIBILITY TO CUSTOM-MAKE

- Characteristics:** Made from a triple layer of breathable semi-rigid material (polyamide, foam and polyester), it has a lumbar plate with belts and buckles for fixing in the chair back, belts passing under the buttocks towards the perineum, holding the thighs from the interior towards the hips. The thigh straps start at the inferior ends, with ratchet belts at the ends, and buckles and adjusters to fasten and adjust.
- Indications:**
 - Suitable for patients who need to keep both legs in permanent abduction.
- Colour:** ■ Blue.



Ref.: 1004

F ... C .. S ... I ...

ABDOMINAL BELT

SIZES	PERIMETER CM	 TOTAL CIRCUMFERENCE OF PERSON AND SEAT OR CHAIR
S/1	86-164	
L/2	96-174	

Characteristics:

Made from a triple layer of breathable semi-rigid material (polyamide, foam and polyester), it has regulation and securement straps with colour-coded buckle fasteners to facilitate positioning. This has a pelvic belt with a perineum strap which secures the patient to the wheelchair or other type of chair or seat, allowing full freedom of movement in the dorsal cervical zone.

Indications:

- Suitable for patients with good anterolateral control whilst seated but with a tendency to slide out of the seat.

Colour: ■ Blue.



Ref.: 1004A

F ... C .. S ... I ...

OPEN-ABDOMINAL BELT

SIZES	PERIMETER CM	 TOTAL CIRCUMFERENCE OF PERSON AND SEAT OR CHAIR
XS/0 (child)	35-190	
S/1	54-190	

Characteristics:

Made of a breathable triple layer of semi-rigid material (nylon, foam and polyester). It has securing straps with buckle closures, colour coded for easy fitting. It consists of a pelvic belt (with opening at the centre) that secures the patient to a wheelchair or other method of seating, allowing full freedom of movement in the dorsal cervical area.

Indications:

- Suitable for patients with good anterolateral control whilst seated but with a tendency to slide out of the seat.

Colour: ■ Blue.



Ref.: 1005

F ... C .. S ... I ...

ABDOMINAL BELT AND PERINEUM PIECE

SIZES	PERIMETER CM	 TOTAL CIRCUMFERENCE OF PERSON AND SEAT OR CHAIR
S/1	94-182	
L/2	104-192	

Characteristics:

Made from a triple layer of breathable semi-rigid material (polyamide, foam and polyester), it has regulation and securement straps with colour-coded buckle fasteners to facilitate positioning. The pelvic belt with perineum strap secures the patient to the wheelchair or other type of chair or seat, but at the same time allows full freedom of movement in the dorsal cervical zone.

Indications:

- Suitable for patients with good anterolateral control whilst seated but with a tendency to slide out of the seat.

Colour: ■ Blue.



Ref.: 1007

F ... C .. S .. I ...

WRIST HARNESS

SIZES	ONE SIZE	

Characteristics:

Made from a triple layer of breathable semi-rigid material (polyamide, foam and polyester), it has regulation and securement straps with buckle fasteners.

Indications:

- Suitable for patients who need to be completely secured to the bed, seat or chair, preventing free movement of the hands, which can be fixed in a relaxed or firm way, for one or both hands.

Colour: ■ Blue.



Ref.: 1008

F ... C .. S .. I ...

ANKLE HARNESS

SIZES	ONE SIZE	

Characteristics:

Made from a triple layer of breathable semi-rigid material (polyamide, foam and polyester), it has regulation and securement straps with buckle fasteners.

Indications:

- Suitable for patients who need to be completely secured to the bed, seat or chair, preventing free movement of the ankles, which are kept relaxed or firm, which can be fixed in a relaxed or firm way, for one or both ankles.

Colour: ■ Blue.

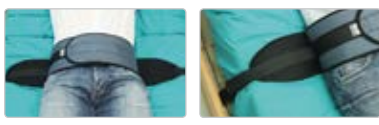

Ref.: 1011

F ... C ... S .. I ...

BED SECURITY HARNESS

SIZES	PERIMETER CM
S/1	70-115
L/2	115-140



For beds up to 150cm wide.



Characteristics:

Made from a triple layer of breathable semi-rigid material (polyamide, foam and polyester), it has regulation and securement straps with colour-coded buckle fasteners to facilitate positioning. It comprises 2 superimposed strips with nylon dobbies.

Indications:

• Suitable for bedridden patients who require securement to prevent falls or unwanted absence from the bed, allowing the patient to make quarter turns to the left or right, therefore preventing any falls.

Colour: Blue.



Ref.: 1010

F ... C ... S .. I ...

HARNESS WITH MAGNETS

SIZES	PERIMETER CM
XS/0	50-70
S/1	70-115
L/2	115-140



For beds up to 150cm wide.

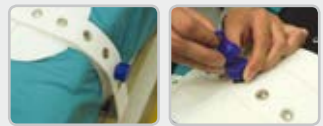

The Arnetec-Fix magnetic fastener system is made up of 3 components:
 1- The metal rod with groove for fastening.
 2- Fixing button with anti-opening mechanism.
 3- Magnetic release device for opening.

Characteristics:

Patients with alteration of physical or mental faculties who require partial or total securement to limit or impede movements of upper and lower limbs and trunk in order to prevent falls, pulling on drip feeds or absences from the bed. Manufactured in polyester 100% and cushioned textured lining inside, the pelvic belt has metal slides to attach the straps which regulate the range of rotation of the patient. The magnetic fastener systems adapted to these harnesses allow for quick and convenient placement of the device, whilst preventing manipulation by the patient or unauthorised persons.

Indications:

• Suitable for bedridden patients who require a control of their mobility and restraint in the bed, whilst allowing small rotational changes of posture to the left or right.

Colour: White.



Ref.: 1013

F ... C ... S .. I ...

HARNESS WRIST TO BELT WITH MAGNETS

SIZES	ONE SIZE



Characteristics:

Manufactured in polyester 100% and cushioned textured lining, with system of magnetic closing, facilitating the rapid and comfortable fitting of the equipment, designed to be used with the trunk harness.

Indications:

• As an addition to the trunk harness, it is suitable for patients which need to be restrained completely to the bed, controlling the degree of freedom of the hands: complete immobilisation, limited range, one hand or both.

Colour: White.



Ref.: 1014

F C .. S .. I

HARNESS WRIST TO BED WITH MAGNETS

SIZES	ONE SIZE	
--------------	----------	---



Characteristics:
Manufactured in polyester 100% and cushioned textured lining, with system of magnetic closing, facilitating the rapid and comfortable fitting of the equipment, and preventing manipulation by the patient or unauthorised persons.

Indications:
• Suitable for bedridden patients who require an independent restriction of the hands, controlling the degree of freedom of the hands: complete immobilisation, limited range, one hand or both.

Colour: White.



Ref.: 1015

F C .. S .. I

HARNESS ANKLE TO BED WITH MAGNETS

SIZES	ONE SIZE	
--------------	----------	---



Characteristics:
Comprising a belt which fixes to the bed, and two independent ankle belts. Manufactured in polyester 100% and cushioned textured lining, with system of magnetic closing, facilitating the rapid and comfortable fitting of the equipment, and preventing manipulation by the patient or unauthorised persons.

Indications:
• Suitable for bedridden patients who require an independent restriction of the ankles, controlling the degree of freedom of the legs: complete immobilisation, limited range, one leg or both.

Colour: White.





Cranial protection helmet



Ref.: H100 | Ref.: H101 | Ref.: H102

CRANIAL PROTECTION HELMET

PERIMETER CM	
46	
48	
50	
52	
54	
56	
58	
60	

CIRCUMFERENCE OF THE HEAD JUST ABOVE THE EARS

Ref.: H101 and H102 are children's models available in sizes 46 to 52.

Characteristics:

The lightweight helmet is made from breathable padded foam and has an interior terry lining and honeycomb fabric covering, providing great strength and durability. Supplied with chin strap and adjustable closure.

Indications:

- Patients with infant cerebral palsy.
- Haemophilia.
- Ataxia.
- Spasticity and in all cases where there is a risk of cranial contusions

Colours:

- Ref.: H101: ■ Green.
- Ref.: H100: ■ Black.
- Ref.: H102: ■ Pink.



Cervical collars



Ref.: CC2106 (6 cm) | Ref.: CC2108 (8 cm)
 Ref.: CC2109 (9,5 cm) | Ref.: CC2111 (11 cm)

F •• C • S • I •

SOFT COLLAR

PERIMETER CM	S/1	M/2	L/3	HEIGHT
CC2106	23-28	29-34		6
CC2108	29-34	35-40	41-46	8
CC2109	29-34	35-40	41-46	9,5
CC2111	29-34	35-40	41-46	11

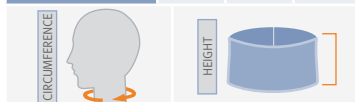

Characteristics:

Made from 6-11 cm-wide polyurethane foam, rear velcro closure, anatomical design, grey colour. 100% cotton.

Indications:

- Minor trauma of bony (spinous and transverse processes) and soft parts (whiplash).
- Postoperative care, torticollis, cervicgia, cervicobrachialgia, compression syndromes, rheumatic and/or degenerative disorders.

Colour:

- Grey.



Ref.: CC2206 (6 cm) | Ref.: CC2208 (8 cm)
 Ref.: CC2209 (9,5 cm) | Ref.: CC2211 (11 cm)

F •• C • S • I •

SEMI-RIGID COLLAR IN POLYURETHANE FOAM WITH POLYETHYLENE REINFORCEMENT

PERIMETER CM	S/1	M/2	L/3	HEIGHT
CC2206	23-28	29-34		6
CC2208	29-34	35-40	41-46	8
CC2209	29-34	35-40	41-46	9,5
CC2211	29-34	35-40	41-46	11

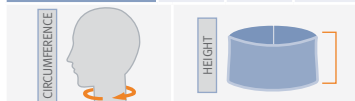

Characteristics:

Made from 6-11 cm-wide polyurethane foam, polyethylene reinforcement band, rear velcro closure, anatomical design, washable grey coloured cover. 100% cotton.

Indications:

- Minor trauma of bony (spinous and transverse processes) and soft parts (whiplash).
- Postoperative care, torticollis, cervicgia, cervicobrachialgia, compression syndromes, rheumatic and/or degenerative disorders.

Colour:

- Grey.



Ref: CC2300

F .. C .. S .. I ..

SEMI-RIGID COLLAR (adjustable)

SIZES	PERIMETER CM	HEIGHT
S/1	30-35	Adjustable (universal)
M/2	35-40	
L/3	40-45	



Characteristics:

Made from two overlapping polyethylene pieces, height-adjustable by means of a Velcro binding, padded on its upper and lower edges, lined with imitation leather, rear Velcro closure system.

Indications:

- Minor trauma of bony (spinous and transverse processes) and soft parts (whiplash).
- Postoperative care, torticollis, cervicgia, cervicobrachialgia, compression syndromes, rheumatic and/or degenerative disorders.

Colour: White.



Ref: CC2400

F .. C .. S .. I ..

SEMI-RIGID COLLAR WITH CHIN SUPPORT (adjustable)

SIZES	PERIMETER CM	HEIGHT
S/1	30-35	Adjustable (universal)
M/2	35-40	
L/3	40-45	



Characteristics:

Made from two overlapping polyethylene pieces, height-adjustable by means of a Velcro binding, the upper piece is designed to accommodate the chin and distribute pressure over its entire surface for optimum comfort. Padded on its upper and lower edges, lined with imitation leather, rear Velcro closure system.

Indications:

- Minor trauma of bony (spinous and transverse processes) and soft parts (whiplash).
- Postoperative care, torticollis, cervicgia, cervicobrachialgia, compression syndromes, rheumatic and/or degenerative disorders.

Colour: White.



Ref: CC2503
(8,3 cm)

Ref: CC2504
(10,8 cm)

F ... C .. S ... I ...

PHILADELPHIA PLASTAZOTE COLLAR

PERIMETER CM	S/1	M/2	L/3	HEIGHT
CC2503	33-41	41-46	46-48	8,3
CC2504	33-41	41-46	46-48	10,8



Characteristics:

Orthosis comprising of front and back pieces, made from plastazote with rigid thermoplastic supports and Velcro strap closures on the sides. Its upper part is designed to make full contact with the lower part of the head by means of an occipital-chin support. Its lower part rests laterally on the shoulders with the front portion situated over the sternum and the rear over the D5 vertebra.

The front part of the collar features a tracheal opening.

It is possible to perform X-rays while the patient is wearing the device, as it contains plastic rivets that do not distort.

Indications:

- Severe trauma with vertebral fractures, postoperative protection (laminectomy), metastasis and, especially, upper cervical injuries (C1-C2).

Colour: Beige.





ANATOMIC ASPECTS

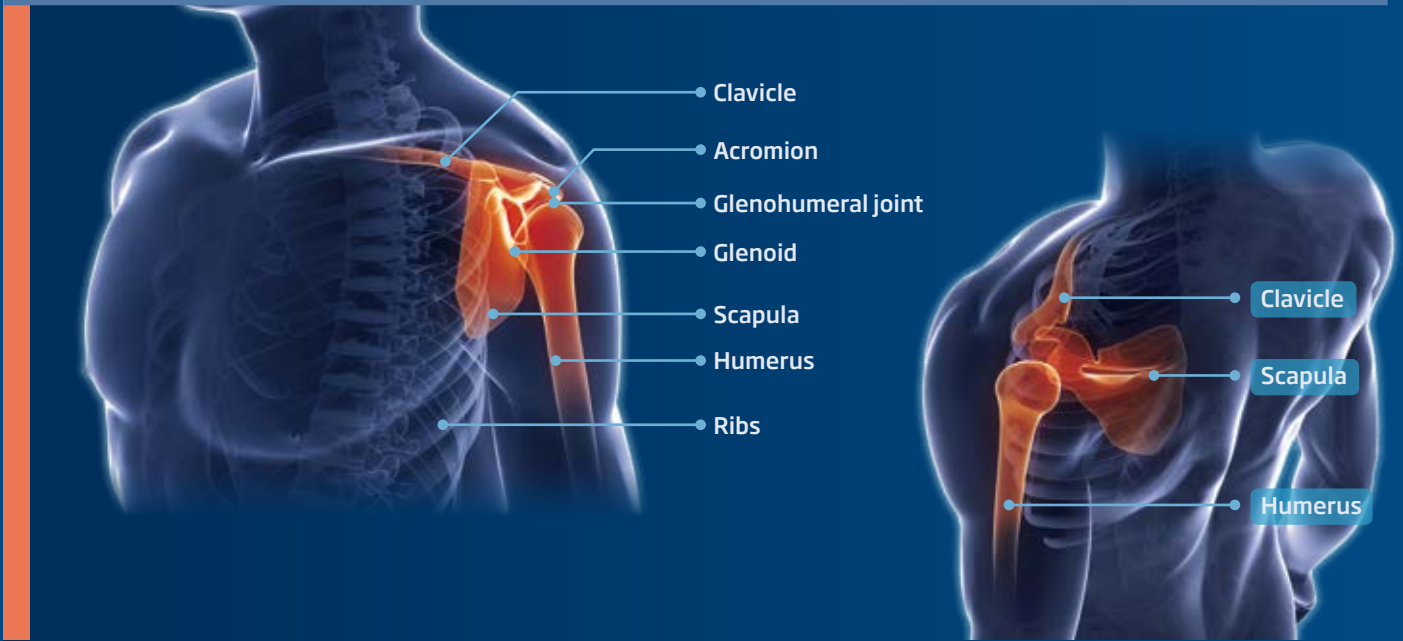

F Fastening C Compression S Stabilisation I Immobilization

Immobilisers > Clavicle & Shoulder Immobilizers



Ref.: IC-30

F C ... S I

CLAVICLE STRAP

SIZES
0 (children)
1
2

Characteristics:

The clavicle splint IC- 30, introduces significant design improvements for better adjustment and increased comfort. The first important point is the new design of the acromion clavicle pad, specifically designed to exert extensive and comfortable pressure on the acromion and humeral head in the deltopectoral area. The axillary area is constructed of microfibre on the inside which produces high quality padding and in turn allows proper ventilation.

Indications:

- Anatomic reminders.
- Stabilisation after injury or surgery.
- Retropulsion of the shoulders.

Colour: Beige.



Ref.: C-40

F . C . S . I .

ARM SLING

SIZES	ONE SIZE



Characteristics:

Sling made from velour with terry cloth lining in bag form for the forearm and Velcro fasteners. Fastening bands allowing regulation of arm height and independent adjustable shoulder immobiliser band on the belt.

Indications:

- Subluxations of the shoulder.
- Mild shoulder injuries.
- Contains and stabilises the scapulohumeral articulation.

Colour: Beige.

Other Models: Ref.: C- 40N (child sling).



Ref.: C-41

F ... C .. S ... I ...

SHOULDER & ARM IMMOBILIZER SLING



SIZES	
1	<38
2	>38



Characteristics:

Support made from velour with bibshape for the forearm, wrapping round it and fastening onto itself allowing height regulation. Extended with two bands on each side of the shoulders, which run over the back and fasten on the forearm with Velcro. It has an additional wide, 15cm, shoulder immobiliser band for subluxations or luxations of the scapulohumeral articulation and when strong immobilisation is required.

Indications:

- Subluxations of the shoulder.
- Mild shoulder injuries.

Colour: ■ Beige.



Ref.: C-42A

Ref.: C-42B

F . C S . I .

ARM SLING



SIZES	LENGTH CM
S/1	<30
M/2	36
L/3	>42

LENGTH IN CM OF FOREARM

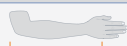

Characteristics:

Made with breathable honeycomb fabric in bag form for elbow and forearm. It has an adjustment band that allows regulation of arm height with neoprene shoulder protection cushion.

Indications:

- Subluxations of the scapulo-humeral articulation. When relief of the shoulder joint is required.
- Contains and stabilises scapulo-humeral articulation.

Colours:

- C-42A: ■ Blue.
- C-42B: ■ Beige.



Ref.: C-43A

F . C S . I ..

SHOULDER & ARM IMMOBILIZER SLING



SIZES	LENGTH CM
S/1	<30
M/2	36
L/3	>42

LENGTH IN CM OF FOREARM

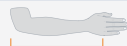

Characteristics:

Manufactured in breathable mesh fabric with pocket for the elbow and forearm. It has a Velcro strap to adjust arm height and a Velcro strap for elbow-body adjustment.

Indications:

- Maintains shoulder-elbow joint in position, supports forearm.
- Prevents descent of humeral head.

Colour: ■ Blue.



Ref.: C-44

F ... C .. S ... I ...

AMBIDEXTROUS VELPEAU SHOULDER IMMOBILISER



SIZES	CONTOUR OF THE TRUNK PLUS THE ARM
S/1	<95
M/2	95-110
L/3	>110

TRUNK → ARM

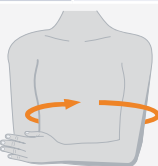

Characteristics:

The Velpeau C-44 orthosis, is indicated in the conservative treatment of humerus neck fractures, is made of a single piece in the form of a harness, where an anatomically designed pad fits the affected shoulder above and is connected to material surrounding the affected forearm. It is manufactured in one piece of poromax-based fabric in a grid type arrangement.

Indications:

- Immobilisation of dislocations of the acromioclavicular joint.
- Conservative treatment of humeral neck fractures.
- Non-displaced and non-joint scapula fractures, anterior shoulder dislocation.
- Conservative treatment of humeral head and lesser tuberosity, acute scapulo-humeral periarthritis.
- Immobilisation of the shoulder after the inflammatory phase.
- Rheumatism, rheumatoid polyarthritis.

Colour: ■ Black.



Ref.: C-48

F • C S • I •

ARM SLING



SIZES	ONE SIZE
-------	----------

Characteristics:

The arm sling consists of an antebrachial support attached to a strap that passes around the back of the neck. The inside of the antebrachial support is made from breathable honeycomb fabric and the outside is velour. The strap has a terrycloth interior and honeycomb exterior and is length adjustable by means of Velcro fasteners, enabling it to be adjusted to the physical characteristics of each patient. The strap is designed to adopt an anatomical shape, which helps to relieve discomfort from pressure at the back of the neck. The Orliman arm sling also has a Velcro fastener to enable the antebrachial support to be adjusted to the needs of each patient. The arm sling is manufactured in one size and can be used on the right or left arm.

Indications:

- Post-operative or post-traumatic immobilisation treatment.
- Arm and shoulder trauma injuries whose treatment requires reduction of mobility.
- Soft tissue injuries such as infections or burns.
- Rheumatic disorders.

Colour: ■ Grey.

Abduction Arm Sling



Ref.: C-45

F ••• C • S ••• I •••

ABDUCTOR SLING (15°/30°)

SIZES	LENGTH CM
S/1	<30
M/2	36
L/3	>42

LENGTH IN CM OF FOREARM



Characteristics:

Manufactured in breathable honeycomb fabric, which allows the free circulation of air to prevent possible irritation. Its design enables control of internal and external rotation, which can be limited by means of the anti-rotational strap. The opening in the front panel enables the patient to do elbow exercises. Hand exercise ball to maintain muscle tone in the hand and improve circulation. Foam abductor cushion with 15°/30° of abduction designed for the patient's maximum comfort.

Indications:

- As an orthopaedic positioning method for sprains, luxation, glenohumeral subluxation.
- Capsular displacement.
- As a conservative treatment for acute and chronic bursitis.
- Rotator cuff repair surgery.
- Shoulder endoprosthesis implantation.
- Adhesive capsulitis.
- Entrapment syndrome.
- After arthroscopic treatment of Bankart lesions.

Colour: ■ Blue.



Ambidextrous sling.



Hand exercise ball to maintain muscle tone and improve blood flow.

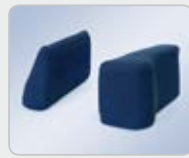

Cushions for 15° abduction. Both cushions can be joined for 30° abduction.



Ref.: C-46

F ••• C • S ••• I •••

ABDUCTOR SLING (30°/45°)

SIZES	ONE SIZE
-------	----------

Characteristics:

Manufactured in breathable honeycomb fabric, it facilitates air circulation to prevent possible irritation. The arm support is made from Poromax® fabric to prevent sweating. On its inner surface, it has a hook closure to fasten it to the velour of the cushion.

Indications:

- As an orthopaedic positioning method for sprains, luxations and glenohumeral subluxations.
- Capsular displacement.
- As a conservative treatment for acute and chronic bursitis.
- In rotator cuff repair surgery.
- In shoulder endoprosthesis implantation.
- Adhesive capsulitis.
- Entrapment syndrome.
- As a method of immobilisation after implantation of a prosthetic shoulder joint and after acromioplasty.

Colour: ■ Blue.



Contralateral padded strap

Ambidextrous sling



Hand exercise ball to maintain muscle tone in the hand and improve circulation



Ref.: C-47

F

...

C

.

S

...

I

...

ORTHOSIS FOR POSITIONING AT 90° OF EXTERNAL ROTATION

SIZES	LENGTH CM
S/1	<30
M/2	36
L/3	>42

LENGTH IN CM OF FOREARM

Characteristics:

Manufactured in breathable honeycomb fabric, it facilitates air circulation to prevent possible irritation. Its design allows a slight shoulder abduction angle of 15° and external rotation of 90°. Hand exercise ball to maintain muscle tone in the hand and improve circulation.

Effets:

Immobilisation of the shoulder and arm at 90° of external rotation with shoulder abduction of 15° or 30°.

Indications:

- As an orthopaedic positioning method for sprains, luxations and glenohumeral subluxations.
- Capsular displacement.
- In rotator cuff repair surgery.
- After arthroscopic treatment of Bankart lesions.
- Repair of soft tissue.

Colour: Blue.



ANATOMIC ASPECTS

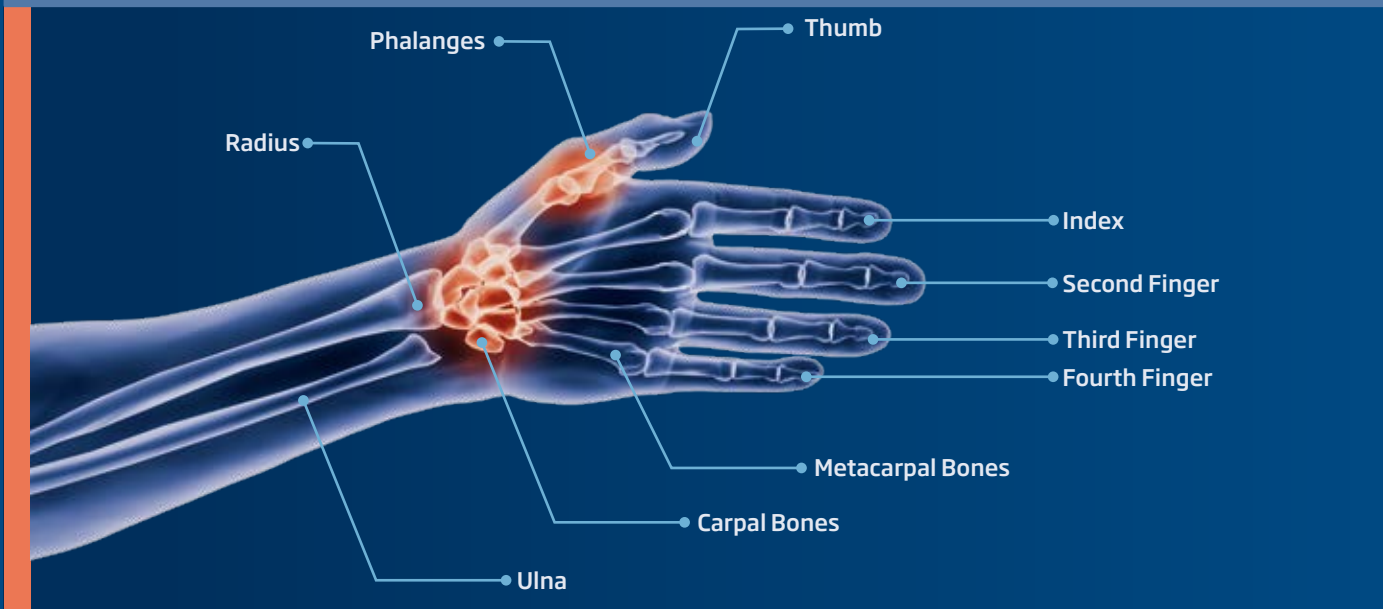

F Fastening **C** Compression **S** Stabilisation **I** Immobilization

Manutec® ▶ Wrist Support



Ref.: MF-D50 RIGHT Ref.: MF-I50 LEFT

F ... **C** **S** **I**

WRIST SUPPORT

SIZES	PERIMETER CM	WRIST	LENGTH
S/1	12-15		
M/2	15-17		18 cm
L/3	17-19		
XL/4	19-21		

Characteristics:

Wrist support with splint made of a soft elastic material, with adjustable Velcro fastenings. Mouldable removable plates with semi-spherical support on the palm.

Indications:

- Immobilisation of the wrist.
- Painful and inflammatory episodes.
- Instability.
- Rehabilitation.

Colour: Beige.



Ref.: MF-D60 RIGHT Ref.: MF-I60 LEFT

F ... **C** **S** **I**

WRIST SUPPORT

SIZES	PERIMETER CM	WRIST	LENGTH
S/1	12-15		
M/2	15-17		22 cm
L/3	17-19		
XL/4	19-21		

Characteristics:

Wrist support with splint made of a soft elastic material, with adjustable Velcro fastenings and elastic Velcro straps on the wrist. Mouldable removable plates with semi-spherical support on the palm area.

Indications:

- Immobilisation of the wrist.
- Painful and inflammatory episodes.
- Instability.
- Rehabilitation.

Colour: Beige.



Ref.: MP-D70 RIGHT Ref.: MP-I70 LEFT

F **C** **S** **I**

SHORT WRIST SUPPORT

SIZES	PERIMETER CM	WRIST	LENGTH
S/1	12-15		
M/2	15-17		
L/3	17-19		13 cm
XL/4	19-21		

Characteristics:

Wrist support with extractable and mouldable thumb splint, made of a soft elastic fabric and Velcro fastener.

Indications:

- Immobilisation and protection of the metacarpophalangeal and carpometacarpal joints.

Colour: Beige.



Ref.: MFP-D80
RIGHT

Ref.: MFP-I80
LEFT

F ... C ... S ... I ...

LONG OPEN ELASTIC WRIST SUPPORT WITH PALM & THUMB SPLINT

SIZES	PERIMETER CM	WRIST	LENGTH
S/1	12-15		
M/2	15-17		
L/3	17-19		
XL/4	19-21		

20 cm

POSSIBILITY TO CUSTOMIZE

Characteristics:

Long wrist support with thumb splint, elastic and soft material, removable and mouldable plate with semi-spherical palm support and thumb plate.

Indications:

- Immobilisation and protection of the metacarpophalangeal and carpometacarpal joints.

Colour: Beige.



SHORT
Ref.: MF-52

LONG
Ref.: MF-61

Ref.: MF-D52 RIGHT

Ref.: MF-I52 LEFT

Ref.: MF-D61 RIGHT

Ref.: MF-I61 LEFT

F ... C ... S ... I ...

SEMI-RIGID WRIST SUPPORT

SIZES	PERIMETER CM	WRIST	LENGTH
S/1	12-15		
M/2	15-17		
L/3	17-19		
XL/4	19-21		

13 cm (MF-52)
21 cm (MF-61)

TRANSPIRABLE MATERIAL

POSSIBILITY TO CUSTOMIZE

Characteristics:

Wrist support made with a semi-rigid cushioned and impermeable fabric and internal cotton boucle with mouldable and removable aluminium splint with semi-spherical palm support, elastic lycra in the dorsal area which facilitates the fitting and Velcro fastening with buckles.

Indications:

- Functional immobilisation of the wrist.
- Painful inflammatory episodes due to arthrosis and arthritis.
- Conservative treatment after surgery or injury.
- Rehabilitation.

Colour: Blue.



Ref.: MF-62 AMBIDEXTROUS

F ... C ... S ... I ...

UNIVERSAL AMBIDEXTROUS WRIST SUPPORT

SIZES	ONE SIZE	LENGTH

21 cm

TRANSPIRABLE MATERIAL

POSSIBILITY TO CUSTOMIZE

Characteristics:

Due to the design of the ambidextrous orthosis, the metallic palm and dorsal splints can vary their position or be eliminated. According to the side and function required of the orthosis, the palm or dorsal splint, or both can be combined, this way acting as a palm, dorsal or complete flexion limiter. Made with textured material.

Indications:

- As a treatment for pain used as an immobilising splint and for rest during rheumatic processes (rheumatoid arthritis, post-traumatic ailments).
- Post-operatives, as a stabilisation method in arthrosis of the wrist.
- Tendonitis and tenosynovitis, and carpal tunnel.

Colour: Blue.



Ref.: MP-D72 RIGHT

Ref.: MP-I72 LEFT

F ... C ... S ... I ...

SHORT SEMI-RIGID WRIST SUPPORT

SIZES	PERIMETER CM	WRIST	LENGTH
S/1	12-15		
M/2	15-17		
L/3	17-19		
XL/4	19-21		

13 cm

TRANSPIRABLE MATERIAL

POSSIBILITY TO CUSTOMIZE

Characteristics:

Wrist support made in semi-rigid, impermeable material, and textured cotton interior fabric with abductable mouldable aluminium thumb splint, elastic lycra in the dorsal area facilitates fitting and Velcro fasteners with buckles.

Indications:

- Functional immobilisation of the thumb.
- Painful inflammatory episodes due to arthrosis and arthritis.
- Conservative treatment after surgery or injury.

Colour: Blue.



Ref.: MFP-D81 RIGHT
Ref.: MFP-I81 LEFT

F ... C ... S ... I ...

SEMI-RIGID LONG WRIST SUPPORT



SIZES	PERIMETER CM	WRIST	LENGTH
S/1	12-15		
M/2	15-17		
L/3	17-19		
XL/4	19-21		21 cm

TRANSPIRABLE MATERIAL

POSSIBILITY TO CUT

Characteristics:

Wrist support made in semi-rigid, impermeable material, and textured cotton interior fabric with abductable mouldable aluminium thumb splint, elastic lycra in the dorsal area facilitates fitting and Velcro fasteners with buckles.

Indications:

- Functional immobilisation of the thumb.
- Painful inflammatory episodes due to arthrosis and arthritis.
- Conservative treatment after surgery or injury.

Colour: ■ Blue.



MAIN FEATURES

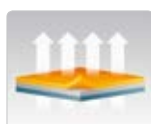

LAST GENERATION MATERIALS
Triple layer transpirable material (foam, velour, sponge).



BILATERAL DESIGN
The design allows the brace to be used on the left and on the right.



AREAS OF TRANSPIRATION AND VENTILATION
Aid the movement of air, dissipating the humidity.



IMMOBILISING SYSTEM
Triple immobilising system.



Ref.: M760 MAROON
Ref.: M660 BEIGE

F ... C ... S ... I ...

IMMOBILISING WRIST SUPPORT WITH PALM SPLINT (AMBIDEXTROUS)

SIZES	PERIMETER CM	WRIST	LENGTH
S/1	14-18		
L/2	18-22		21 cm

Characteristics:

Wrist splint manufactured from breathable velour, made using last generation materials (triple layer: foam, velour, sponge), with a triple immobilisation system comprising a malleable aluminium palm splint and medial-lateral anatomically shaped strips for adaptation.

Indications:

- Wrist immobilisation.
- Post-trauma.
- Postsurgery.
- Painful or swollen sequelae.
- Instability.
- Rehabilitation.

Colours:

M760: ■ Maroon.
M660: ■ Beige.



A new closure and adjustment system consisting of a forearm strap and wrist closure, whose single strap design enables wrist and hand adjustment.



In the palmar area, a double velcro strap system enables adjustment to the width of the hand's metacarpal area.



Ref.: M700 MAROON
Ref.: M600 BEIGE

UNIVERSAL WRIST SUPPORT

SIZES	ONE SIZE
-------	----------

Characteristics:

Simple wrist support manufactured from breathable velour, made using last generation materials (triple layer: foam, velour, sponge), and a closing system of a velour strap, rings and micro-velcro. The strap can be used to wrap around the wrist, or can be cut and used as a simple closing strap.

Indications:

- Prevention of wrist injuries.

Colours:

M700: ■ Maroon.
M600: ■ Beige.



F Fastening **C** Compression **S** Stabilisation **I** Immobilization

Manutec® Fix Rizart ▶ Bilateral Wrist Support



MAIN FEATURES



LAST GENERATION MATERIALS
Triple layer transpirable material (foam, velour, sponge).



BILATERAL DESIGN
The design allows the brace to be used on the left and on the right.



AREAS OF TRANSPIRATION AND VENTILATION
Aid the movement of air, dissipating the humidity.



IMMOBILISER SYSTEM
Of the trapeziummetacarpal joint.

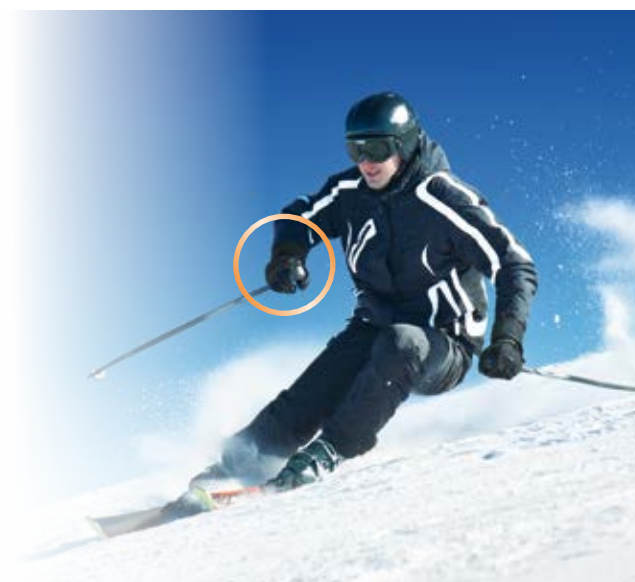

Ref.: M770 MAROON **Ref.: M670** BEIGE

F ... **C** .. **S** ... **I**

BREATHABLE THUMB IMMOBILISING SPLINT (AMBIDEXTROUS)

SIZES	PERIMETER CM	LENGTH
S/1	14-18	11
L/2	18-22	13

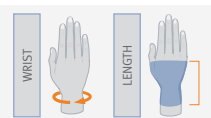

Characteristics:

The splint is made of breathable velour, which has orifices on the surface to facilitate the movement of air. With an immobiliser system which consists of a malleable aluminium splint which can be shaped to the morphology of the patient. Bilateral design which can be adapted for both the left and right hand. Closing system with a velour strap, and hook closure.

Indications:

- Tendonitis.
- Painfull or swollen sequelae.
- Instability of the trapeziummetacarpal joints.
- Sports injuries (eg.: skier's thumb).
- Irritations of the trapeziummetacarpal joints.
- Immobilization of the trapeziummetacarpal joint (Thumb rhizarthrosis).

Colours:

M770: ■ Maroon.
M670: ■ Beige.





Ref.: FP-D71 RIGHT | Ref.: FP-I71 LEFT

F ... C .. S ... I



THUMB SPLINT IN THERMOPLASTIC

SIZES	PERIMETER CM	LENGTH CM	WRIST	LENGTH
S/1	<17	11		
M/2	17-19	12		
L/3	>19	13		

Characteristics:

Posture thumb splint in thermoplastic, lined with plastazote and fastening with Velcro strap at wrist level.

Indications:

- Prevents deviations in rheumatic deformities.
- In postoperative care. In rhizarthrosis of the thumb (by immobilisation of the trapeziummetacarpal joint).
- Possibility of molding with hot air pistol.

Colour: ■ Beige.



Ref.: FP-D74 RIGHT | Ref.: FP-I74 LEFT

F .. C .. S ... I



BREATHABLE THUMB IMMOBILISING SPLINT

SIZES	PERIMETER CM	LENGTH CM	WRIST	LENGTH
S/1	<17	11		
M/2	17-19	12		
L/3	>19	13		

Characteristics:

Immobilising splint in thermoplastic which includes a very comfortable breathable interface. The splint has a small micro-velcro fastener which can be adjusted to fit to the required length.

Indications:

- Tendonitis.
- Painful and inflammatory sequels.
- Instability of metacarpophalangeal joints.
- Sports injuries (eg, skier's thumb).
- Irritations of the metacarpophalangeal joints.
- Immobilisation of the trapezo-metacarpal joint. (Rhizarthrosis of the thumb).
- Immobilisation of the metacarpophalangeal joints in the thumb (after injury or surgery)

Colour: ■ Beige.

The breathable lining can be ordered separately.
Ref: Forro-FP74



Ref.: FP-D75 RIGHT | Ref.: FP-I75 LEFT

F .. C .. S ... I



QUERVAIN SPLINT

SIZES	PERIMETER CM	LENGTH CM	WRIST	LENGTH
S/1	<17	18		
M/2	17-19	20		
L/3	>19	22		

Characteristics:

Thermoplastic immobiliser splint lined in plastazote, with two rigid Velcro fasteners at wrist and forearm level and an elastic strap at palm level.

Indications:

- Tendonitis.
- Painful and inflammatory episodes.
- Instabilities of the carpometacarpal and metacarpophalangeal joints.
- Injuries of the lateral ligaments of the primary metacarpal (sports and posttraumatic injuries).
- Irritations of the carpometacarpal and metacarpophalangeal joints.
- Immobilisation of the trapezium-metacarpal joint (Rhizarthrosis of the thumb).
- Immobilisation of the carpometacarpal and metacarpophalangeal joints of the thumb (post-traumatic and post-surgical).

Colour: ■ Beige.



V Finger immobilising glove splint



Ref.: M710D
RIGHT

Ref.: M710I
LEFT

F ... C .. S I

GLOVE SPLINT FOR THE IMMOBILISATION OF THE METACARPOPHALANGEAL AND INTERPHALANGEAL JOINTS OF THE HAND AND FINGERS IN EXTENSION OR FLEXION

SIZES	PERIMETER CM	FINGER LENGTH CM
S/1	15-17	7,5-8,5
M/2	17-19	8,5-9,5
L/3	19-22	9,5-11
XL/4	22-25	11-12,5

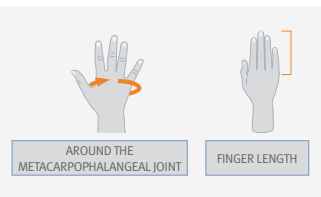

Easy-to-use splint adjustment system



Possibility of alternating the splints on different fingers

Characteristics:

A glove made from velour and honeycomb fabric in the interior, hook closure with safety strap. Independent finger splints with metal strip and closure system with velour and hook fastening. The finger splints are made from malleable aluminium, enabling adjustment of the extension or flexion of the metacarpophalangeal (MCP) and interphalangeal (IP) joints.

Indications:

- As a method for immobilising the metacarpophalangeal and interphalangeal joints.
- Finger fractures, dislocations, trauma injuries, capsular ligamentous injuries, metacarpal fractures, retractile scars in burns cases, bursitis.
- As a method of postoperative immobilisation.
- Dupuytren disease.

Colour: Black.

ACCESSORIES



Ref.: FRD10

CLOSED-FINGER SPLINTS

SIZES	FINGER LENGTH
1	7,5-8,5
2	8,5-9,5
3	9,5-11
4	11-12,5



Ref.: FRD20

OPEN-FINGER SPLINTS

SIZES	FINGER LENGTH
2	8,5-9,5
4	11-12,5

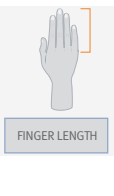

Ref.: PM10

SPLINT TO EXTEND IMMOBILISATION TO THE WRIST JOINT

SIZES ONE SIZE

Stack Splints



Ref.: TP-6200

STACK SPLINTS

F ... C . S I

SIZES	PERIMETER CM
1	5
2	5,5
3	5,8
4	6,1
5	6,3
5,5	6,8
6	7,3
7	7,8

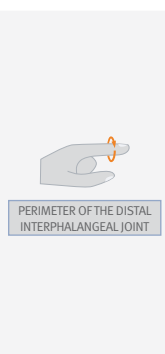

Characteristics:

The splint is manufactured from polypropylene (flesh colour). The lower part goes from the distal zone of the finger until it exceeds the distal interphalangeus articulation, and has a thimble shape to house the tip of the finger. The upper section is joined to the lower section to leave the nail zone free, and stretches to the distal interphalangeus articulation.

Indications:

- Extractions of the extensor for its insertion in the dorsal face of the distal phalange.

Packaging: Bag with 1 unit.

Colour: Beige.

Immobilising Frog Finger Splint In Malleable Aluminium



Ref.: OM6201

F C S I

IMMOBILISING FROG FINGER SPLINT IN MALLEABLE ALUMINIUM

SIZES	PERIMETER CM
S/1	5,7
M/2	7
L/3	7,6

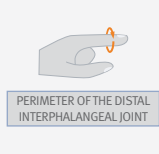

Characteristics:

Its manufacture in malleable aluminium and its interior lining enable it to be adapted to any finger without the need for a closure system. It can be used on either hand. Foam avoids sweating in the area.

Indications:

- It is indicated for cases where it is necessary to immobilise the distal interphalangeal joint and can be adjusted to the desired position of the finger.

Colour: Blue.



Splints in Thermoplastic

F C S I



Ref.: TP-6100D RIGHT	Ref.: TP-6100I LEFT	Ref.: TP-6105D RIGHT	Ref.: TP-6105I LEFT
-------------------------	------------------------	-------------------------	------------------------

WRIST IMMOBILIZATION SPLINT (IN DORSIFLEXION 35°-40°)

WRIST IMMOBILIZATION SPLINT (IN DORSIFLEXION 20°)

Ref: TP-6100

Ref: TP-6105

SIZES	PERIMETER CM	LENGTH CM	SIZES	PERIMETER CM	LENGTH CM
S/1	14-16	22	S/1	<15	21
M/2	16-18	24	M/2	15-17	22
L/3	18-20	26	L/3	17-19	23
			XL/4	>19	24

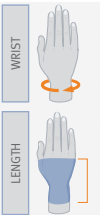

Characteristics:

Made from thermoplastic and lined with Plastazote, it has 3 velour straps with safety inserts in the wrist and forearm and a hook closure system. The plastic can be moulded under a current of hot air.

Indications:

- As a general treatment for pain or post-traumatic pain, helps to stabilise the wrist after arthrodesis.
- As a treatment post-operatively, for carpal tunnel syndrome, tenosynovitis or inflammation in the carpal region.
- Its features allow for small adjustments or adaptations.

Colour: White.



Ref.: TP-6101DA RIGHT	Ref.: TP-6101IA LEFT
--------------------------	-------------------------

F C S I

ARTICULATED WRIST ORTHOSIS

SIZES	WIDTH CM	LENGTH CM
S/1	6-7	34
M/2	7-8	36
L/3	8-9	38
XL/4	9-10	40

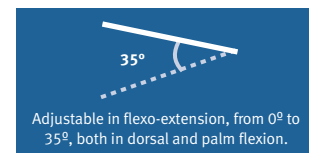

Adjustable in flexo-extension, from 0° to 35°, both in dorsal and palm flexion.

Characteristics:

Made of two pieces of thermoplastic (palm and forearm), connected by a wrist joint that allows you to adjust the palm and dorsal flexion of the orthosis, limiting the range of movements of the wrist joint or immobilizing it in a set position. The lateral splints contain slots that allow you to move the thermoplastic pieces closer to or further from each other, which allows us to adjust the orthosis to each patient's measurements. They feature an interior terrycloth lining to avoid sweating. It includes 3 velour straps with a security pin on the wrist and forearm, and a Velcro fastening system. The orthosis can be molded using a hot-air gun.

Indications:

- All pre and post-op conservative treatments that require functional support or immobilization of the wrist, such as carpal tunnel syndrome, chronic polyarthritis, and rheumatoid arthritis.
- It is also indicated for central or peripheral neurological damage (spastic and flaccid paralysis), treatment for the prevention of rheumatoid deformities, as well as pain relief and anti-inflammatory treatment.

Colour: Beige.



Splints in Thermoplastic



Ref.: TP-6101D
RIGHT

Ref.: TP-6101I
LEFT

F ... C .. S ... I ...

FUNCTIONAL POSITION HAND IMMOBILISATION SPLINT WITH THUMB IN OPPOSITION

SIZES	WIDTH CM	LENGTH CM	HAND WIDTH	LENGTH
S/1	6-7	34		
M/2	7-8	36		
L/3	8-9	38		
XL/4	9-10	40		

Characteristics:

Made from thermoplastic and lined with absorbent terry cloth to absorb moisture, it has 3 velour straps with safety inserts in the wrist and forearm and a hook closure system. The plastic can be moulded under a current of hot air.

Indications:

- Neurological damage of central or peripheral origin (spastic and flaccid paralysis), as treatment for the prevention of rheumatic deformities as well as for pain relief and to reduce inflammation.
- Carpal tunnel syndrome.

Colour: White.



Ref.: TP-6102D
RIGHT

Ref.: TP-6102I
LEFT

F ... C .. S ... I ...

ANTI-SPASTICITY HAND IMMOBILISATION SPLINT

SIZES	WIDTH CM	LENGTH CM	HAND WIDTH	LENGTH
XS/0	5-6	30		
S/1	6-7	34		
M/2	7-8	36		
L/3	8-9	38		
XL/4	9-10	40		

Characteristics:

Made from thermoplastic and lined with absorbent terry cloth to absorb moisture and increase comfort. The plastic can be moulded under a current of hot air. It has wrist and forearm straps with safety inserts and the thumb in velour. Restraint and control straps for MCP and IP flexion in velour, and lined with silicone.

Indications:

- Resting splint for the treatment of pain, neurological disorders, hemiplegia.
- Especially indicated for spastic paralysis, for protecting the palm, the hand and wrist from inhibitory reflexes, preventing deformities caused by spasms and contractions and preventing claw hand.

Colour: White.



Ref.: TP-6103D
RIGHT

Ref.: TP-6103I
LEFT

F ... C .. S ... I ...

WRIST IMMOBILISATION SPLINT (IN DORSIFLEXION) WITH THUMB

SIZES	WIDTH CM	LENGTH CM	HAND WIDTH	LENGTH
S/1	6-7	22		
M/2	7-8	24		
L/3	8-9	26		
XL/4	9-10	28		

Characteristics:

Made from thermoplastic and lined with Plastazote, it has 3 velour straps with safety inserts in the wrist and forearm and a hook closure system. The plastic can be moulded under a current of hot air.

Indications:

- As a general treatment for pain or post-traumatic pain, and helps to stabilise the wrist after arthrodesis.
- Also recommended for thumb rhizarthrosis, injuries that require metacarpophalangeal immobilisation of the thumb and Bennett's fracture dislocation.

Colour: White.



Ref.: TP-6104D
RIGHT

Ref.: TP-6104I
LEFT

F ... C .. S ... I ...

IMMOBILISATION SPLINT FOR HAND IN FLAT FUNCTIONAL POSITION

SIZES	WIDTH CM	LENGTH CM	HAND WIDTH	LENGTH
S/1	6-7	34		
M/2	7-8	36		
L/3	8-9	38		
XL/4	9-10	40		

Characteristics:

Made from thermoplastic and lined with absorbent terry cloth to absorb moisture and increase comfort. The plastic can be moulded under a current of hot air. It has wrist and forearm straps with safety inserts and the thumb in velour. Restraint and control straps for MCP flexion in velour.

Indications:

- Neurological damage of central or peripheral origin (spastic and flaccid paralysis), as treatment for the prevention of rheumatic deformities as well as for pain relief and to reduce inflammation.
- Carpal tunnel syndrome.

Colour: White.

ANATOMIC ASPECTS

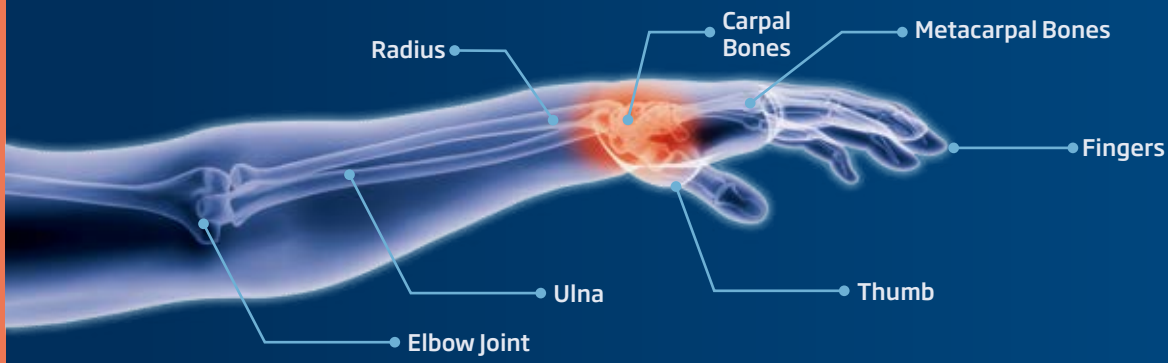

F Fastening **C** Compression **S** Stabilisation **I** Immobilization

Malleable aluminium hand brace

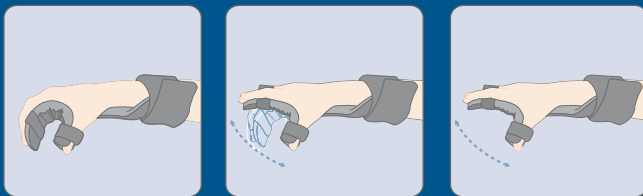

1. FLEXION

2. EXTENSION

SPLINT POSITIONS

Various intermediate positions between the above two extreme positions are possible, including the functional position by manually manipulating the malleable aluminium for different angles and postures.



Ref.: OM6101D
RIGHT

Ref.: OM6101I
LEFT

F .. **C** . **S** ... **I** ...

MALLEABLE ALUMINIUM THUMB AND HAND IMMOBILISING SPLINT

SIZES	WIDTH CM	LENGTH CM	HAND WIDTH	LENGTH
S/1	5-7	31'5		
M/2	7-9	34		
L/3	9-11	36'5		

Components:
Splint + Interdigital separator.

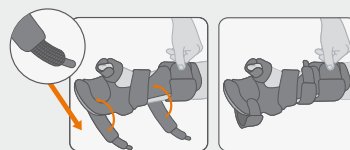

SECURING STRAPS

Securing straps great cushioning and support in micro-velcro, with easy-open tab and close. Allows you to modify the position of wrist, hand and fingers to test doctor.

Characteristics:

Made from a malleable aluminium core for appropriate adjustment and positioning, according to medical requirements, of the wrist, hand, fingers and thumb. Foam padding inside for greater comfort. Absorbent terrycloth lining to absorb perspiration. Velour lining exterior. The splint has various fitting options, with intermediate positions possible by manually manipulating the malleable aluminium for different postures and angles.

Suitable for:

- Central or peripheral origin neurological damage (flaccid paralysis).
- As a treatment for the prevention of rheumatic deformities.
- Pain relief and inflammation reduction.
- Carpal tunnel syndrome, due to the various postural options.

Colour: Black.



ACCESSORIES



Ref.: OM001

INTERDIGITAL SEPARATOR

This accessory is to separate and align the fingers.

SIZES UNIVERSAL 1 UNIT



Ref.: OM002I (LEFT)

KIT FOR SPLINT STRAPS OM6101I

You can request a kit of 3 fastening straps. Including: One for the thumb strap, a strap for fingers, wrist and forearm girth.

Ref.: OM002D (RIGHT)

KIT FOR SPLINT STRAPS OM6101D

SIZES UNIVERSAL

ANATOMIC ASPECTS

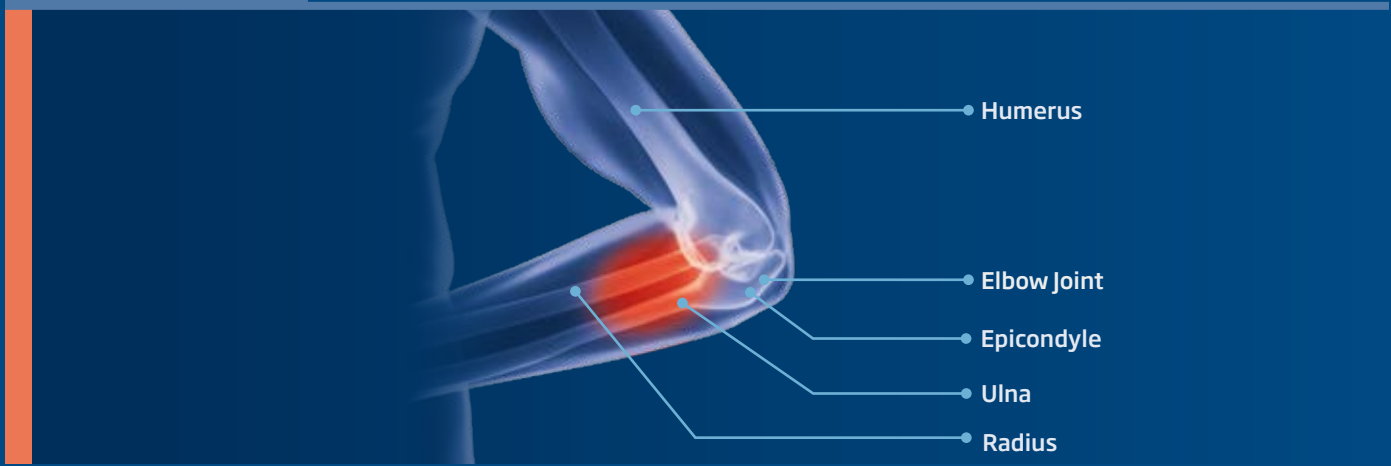

F Fastening **C** Compression **S** Stabilisation **I** Immobilization

Epitec® Fix ▶ Epicondylitis Armband

Sin
LATEX
free



Exhibitor

Ref.: Exp-E21-Cartón
Units: 10
Sizes: 50 x 20 cm



ADJUSTABLE SILICONE

Silicone points which stick to the skin by pressure and impede slipping of the orthosis on the forearm.



CUSHION

Made of viscoelastic material with special pressure points which apply a selective pressure at the same time as an effective massage and is lined on one side with a soft hypoallergenic towel and on the other with micro-velcro which allows it to stick to the orthosis and thus avoiding slipping.



FASTENING STRAP

It adjusts to the forearm and wraps around itself with a plastic buckle joined to an elastic regulating band which allows individualized adaptation of pressure according to a fixed scale. The area of closure is reinforced with soft Velcro to achieve a stronger and longer-lasting adjustment.



SOUL OF THERMOPLASTIC

Molded and shaped to fit the shape of the upper arm and serves as subject to the locking pin buckle. When performing the compression positions of the forearm muscles causing decompression and relief.



Ref.: EP-21G GREY

Ref.: EP-21V GREEN

F • **C** ... **S** .. **I** •

EPITEC FIX EPICONDYLITIS ARMBAND

SIZES

ONE SIZE

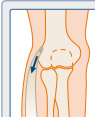

With the EPITEC FIX straps, pressure is applied through a viscoelastic cushion with special adjustment points. Correctly positioned, these reduce the force of traction which results from the insertion of the epicondyle musculature tendon; achieving this through the orientation of the muscular fibres.

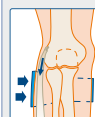

Characteristics:

The external side is made with highly resistant cushioned materials, internally with a moulded and shaped thermoformed plastic soul, and with silicone points that stick to the skin's pressure. Easily regulated with the closing band and the elastic band.

Indications:

- Prevention of sporting and work-related injuries.
- Epicondylitis (tennis elbow).
- Epitrocleitis (golfer's elbow).

Colours:

- EP-21G: Grey.
- EP-21V: Green.

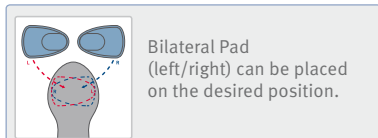

Ref: EP-20A

F • C ••• S •• I •

EPICONDYLITIS ARMBAND

SIZES	ONE SIZE	
-------	----------	--

The design of the condylar pad exerts selective compression.

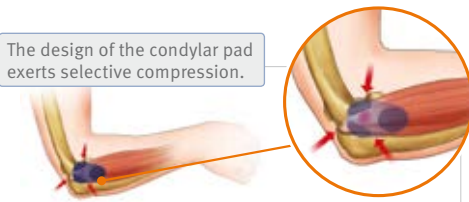

Characteristics:

Made of velour on both sides and reinforced with a core of polyethylene and plastazote padding. The closure strap is adjusted on the forearm and fastens back on itself, making it individually adaptable according to the pressure exerted by its elasticated cuff with hook fastener.

Indications:

- Sports and work injury prevention.
- Epicondylitis (tennis elbow).
- Epitrochleitis (golfer's elbow).

Colour: ■ Blue.

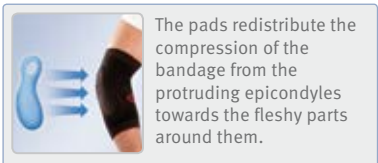

Ref.: 8301 BEIGE

Ref.: 9301 BLACK

F ••• C •••• S • I •

ELASTIC ELBOW SUPPORT WITH VISCOLASTIC PADS

SIZES	PERIMETER CM	LENGTH CM
XS/1	17-19	21,5
S/2	19-21	22
M/3	21-23	22,5
L/4	23-25	24
XL/5	25-27	24
XXL/6	27-29	24
XXXL/7	29-31	24,5

12CM FROM THE ELBOW



Characteristics:

Developed in breathable elastic woven fabric using flat weaving, it incorporates two anatomically-shaped Viscolastic pads which redistribute the compression on the epicondyle and epitrochlea.

Indications:

- Epicondyle pathologies (e.g. tennis elbow, golf elbow), osteoarthritis and arthritis.
- States of postoperative and post-traumatic irritation, tendinopathies, epicondylitis, prevention of sports or work-related injuries.

Colours:

8301: ■ Beige.
9301: ■ Black.



F •••• C ••• S •••• I •••••

Ref.: 94300

FLEXION-EXTENSION CONTROL AND ELBOW ORTHESIS

Ref.: 94301D RIGHT

Ref.: 94301I LEFT

FLEXION-EXTENSION CONTROL & ELBOW ORTHESIS WITH PALM SPLINT

Ref.: 94302D RIGHT

Ref.: 94302I LEFT

FLEXION-EXTENSION CONTROL & ELBOW ORTHESIS WITH PALM-THUMB SPLINT

SIZES	PERIMETER OF WRIST A	PERIMETER OF WRIST B	PERIMETER OF WRIST C <small>Only model references Ref.: 94301/94302</small>
S/1	26-32	20-25	<18
M/2	32-37	25-30	18-22
L/3	37-43	30-35	>22

APPROXIMATE LENGTH (minimum 42, maximum 44 cm).

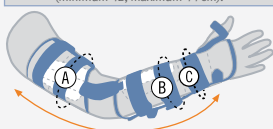

Characteristics:

Made up of an arm valve and a forearm valve joined together via a mono-central articulation with the possibility of adjustment of the flexo-tension through 0° to 90° in intervals of 30°. Thermoplastic nucleus that provides support and rigidity. Bands adjust the double sided velour through the use of a buckle.

Indications:

- Diaphysary fractures of the humerus, fractures of the middle to lower third of the humerus (supra-condylar).
- Fractures of the ulna and radius.
- Pathological fractures (osteolytic metastasis).
- In surgery of the elbow ligaments.
- With palmar splints: in case of neurapraxia (temporary paralysis), due to the traumatic agent, the use of this orthosis is recommended with a palmar support.
- In case of radial paralysis use with a palmar splint is recommended with abduction of the thumb.

Colour: ■ Grey.

Orthosis for arm and forearm in thermoplastic



Ref.: TP-6300 **F** **C** **S** **I**

ARTICULATED ELBOW ORTHOSIS, WITH ARM AND FOREARM IN THERMOPLASTIC

Characteristics:

Modular orthosis for the upper arm composed of a brace for the humerus, a brace for the forearm and hand support, elbow articulation with flex-extension adjustment and guide for correct size, adjustment straps and microhook fastening system. Can be cut to the desired length, linked with 1 mm polyethylene tabs, with additional shoulder strap. Internal plastazote padding.

Indications:

- Fractures of the humeral diaphysis.
- Whether by direct or indirect trauma.
- Pathological fractures.
- Surgical treatment of fractures, or fractures associated with paralysis.
- As an aid to the treatment of upper arm fractures associated with the elbow joint.
- Hand support indicated in cases where the fracture is associated with paralysis or as required (Ref.: TP-6301).

Colour: White.

TP-6300	TP-6301	LENGTH	SIZES	HUMERUS		FOREARM		*
				PROXIMAL	DISTAL	PROXIMAL	DISTAL	
				A	B	C	D	
35-47	35-57	XS/1		25	22	22	19	±3
35-47	35-57	S/2		27	24	24	21	±3
35-50	35-60	M/3		30	27	27	24	±4
35-50	35-60	L/4		32	29	29	26	±4
35-50	35-60	XL/5		34	31	29	26	±4

*The range can vary in:

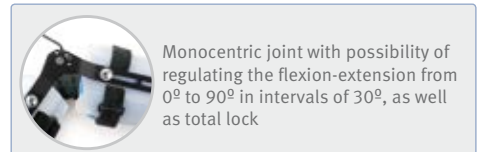
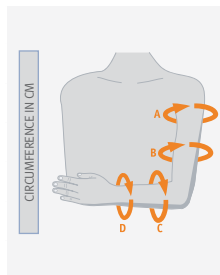

Movement control:
Via the elbow joint with a flex-extension adjustment to limit the mobility of the elbow as desired. Protection given to the area of the fracture from external impact, rotational movements or other unwanted physical forces.



Ref.: TP-6400 **F** **C** **S** **I**

HUMERUS BRACE IN THERMOPLASTIC

LENGTH	SIZES	HUMERUS		*
		PROXIMAL	DISTAL	
		A	B	
29	XS/1	25	22	±3
30,5	S/2	27	24	±3
32	M/3	30	27	±4
34	L/4	32	29	±4
34	XL/5	34	31	±4

*The range can vary in:

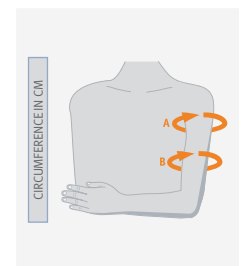

Characteristics:

Thermoshaped, two-piece humerus brace in low-density polyethylene, velour adjustment straps and microhook fastening system. Can be cut according to the desired length, coupled with 1 mm polyethylene tabs. Internal plastazote padding.

Indications:

- Diaphyseal fractures of the humerus.
- Post-surgical treatment of fractures and control of the instability of the fractured area during the healing process.

Colour: White.

Humerus Brace



Ref.: TP-6401

Ref.: TP-6402
SHORT MODEL

F C S I

THERMOPLASTIC HUMERAL BRACE WITH FABRIC COVERING

Characteristics:

Bi-valve thermoformable humeral orthosis in low-density polyethylene and covered with padded fabric. Breathable interior honeycomb lining.
2 thermoplastic pieces incorporated into the lining and joined by elasticated fabric.
Adjustment by means of two velour straps with Velcro closure.
Suspension and fastening system by means of a chest strap.
The brace also comes with an arm support strap.

Indications:

- Humeral shaft fractures, post-surgical fracture treatment and control of fracture site instability during the consolidation process.

Colour: Black.

TP-6401 | TP-6402

LENGTH CM		SIZES	HUMERUS A CM
27,5	22,5	XS/1	22,5 - 26
29,5	24,5	S/2	26 - 29,5
32	27	M/3	29,5 - 33
33	28	L/4	33 - 36,5
35	30	XL/5	36,5 - 40

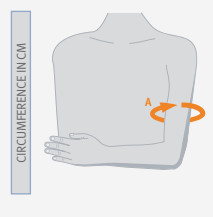



Ref.: 94303D RIGHT | **Ref.: 94303I LEFT**

SHOULDER SUPPORT WITH ARM AND FOREARM STRAP

F ... **C** ... **S** ... **I** ...



Ref.: 94304D RIGHT | **Ref.: 94304I LEFT**

SHOULDER SUPPORT WITH FOREARM STRAP

F ... **C** ... **S** ... **I** ...

Characteristics:

An orthosis made from breathable foam with velour exterior and inner honeycomb fabric lining, with Velcro strap and push button buckle closure systems. The support is reinforced by a 0.5 mm-thick thermoplastic core to increase its support capacity, prevent malformation and enable a personalised fit. Forearm strap with Velcro closure system and loops for the adjustment straps with inner pimpled silicone to prevent movement. Designed to facilitate free arm movement and to enable the patient to fit the support with one hand.

Effects:

Stabilisation of the shoulder joint.
Shoulder subluxation and internal rotation control.
As a method to reduce capsular ligament tension in paralysed or unstable shoulders.
Prevention of pain and subluxation.

Indications:

- Neurological injuries to the upper limb.
- Brachial plexus injury with shoulder and arm paralysis.
- Hemiplegia caused by a stroke.
- Peripheral nerve and brain trauma injuries.
- Painful and unstable shoulder.

Colour: ■ Black.

SIZES	S/1	M/2	L/3
PERIMETER CM	22,5-28	28-34	34-40

CIRCUMFERENCE IN CM



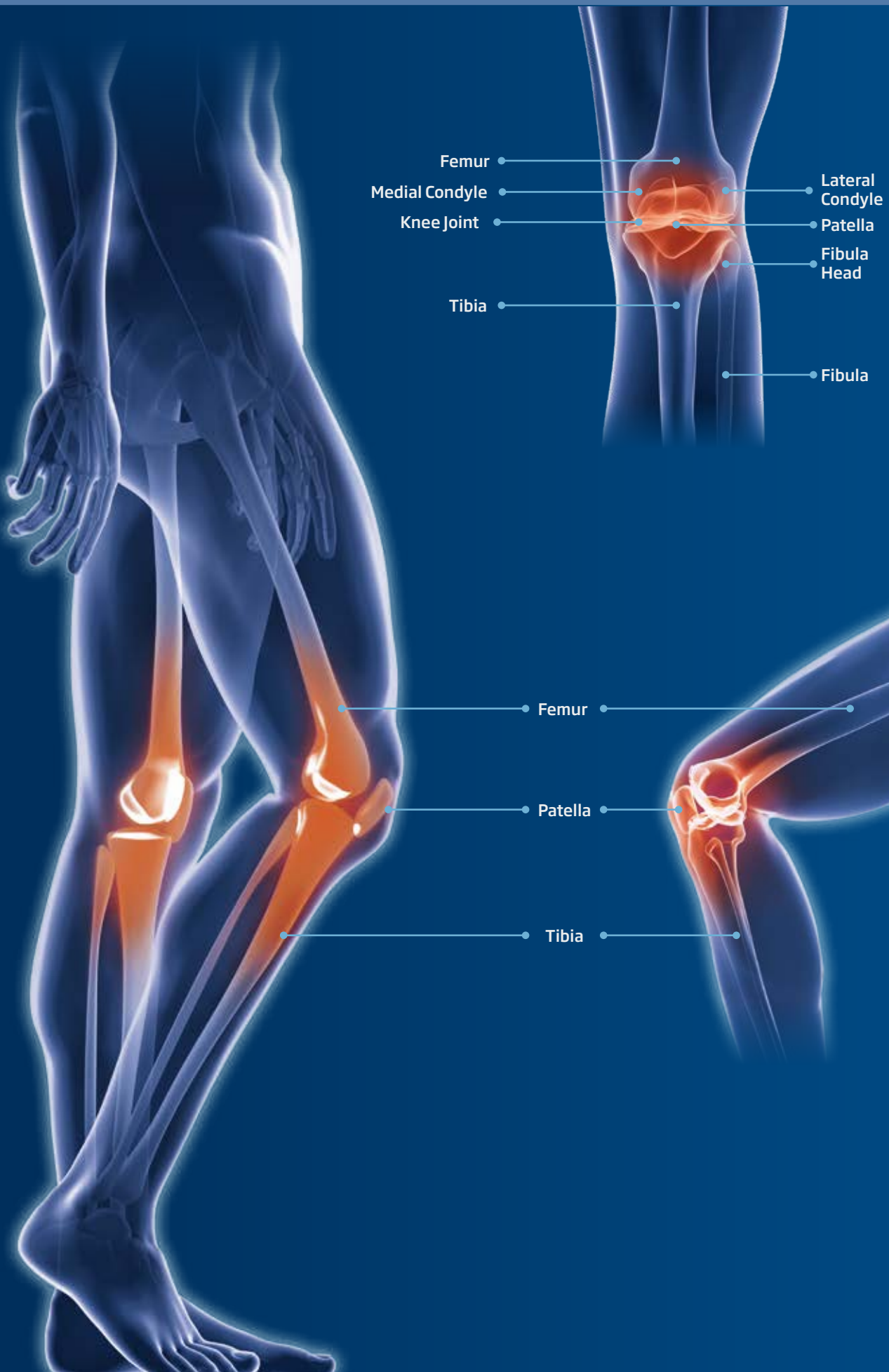

MAIN FEATURES

AREAS WITH DIFFERENT STITCHING FOR SELECTIVE ADJUSTMENT

At the top, the compression is less.

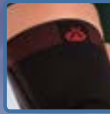

High elasticity for easier fitting and removal.



Three-dimensional knitted fabric, elastic and breathable, for proper fitting to the shape of the knee.

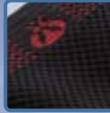

With viscoelastic padding inside, giving the patient an intermittent massage. The material is softer in the popliteal area.



The material is softer in the popliteal area.



At the bottom, the compression is less.



Flexible stabilisers inserted at the side to prevent folding, allowing the brace to move smoothly and improving mediolateral control.

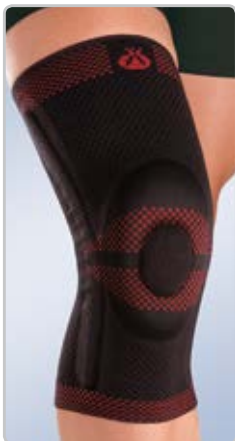
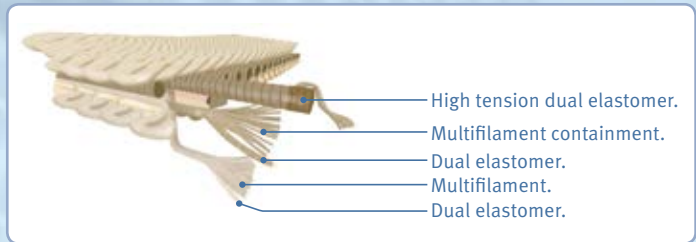

Ref.:9104



Ref.:9105

Ref.: 8104 BEIGE | Ref.: 9104 BLACK

F .. **C** ... **S** .. **I** ..

CLOSED PATELLA KNEE BRACE W/SILICONE PAD & LATERAL FLEXIBLE REINFORCEMENTS

Ref.: 8105 BEIGE | Ref.: 9105 BLACK

F .. **C** ... **S** .. **I** ..

OPENED PATELLA KNEE BRACE W/SILICONE PAD & LATERAL FLEXIBLE REINFORCEMENTS

SIZES	PERIMETER CM A	PERIMETER CM B
XS/1	38-41	28-31
S/2	41-44	31-34
M/3	44-47	34-37
L/4	47-50	37-40
XL/5	50-53	40-43
XXL/6	53-56	43-46
XXXL/7	56-59	46-49

A-Point of measurement: outline halfway up thigh
B-Point of measurement: outline halfway up calf

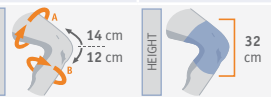

Characteristics:

Developed using three-dimensional knitted fabric, providing greater transversal elasticity at the same time as it exerts the necessary compression in each area, this new knitted fabric concept provides better hold on the skin and stability during movement, and does not require any fastening system, incorporates a visco-elastic cushion in ring form which manages the kneecap control, with blockage, in an upper and lower lateral sense. Incorporates lateral stabilisers on both sides which prevent it rolling up and give a greater medio-lateral control.

Indications:

- Irritation (tendomyopathy, first phase ligamentosis, mild arthrosis, post-traumatic and postoperative arthritis).
- Sensation of instability (patellar and/or medio-lateral).

Colours:

- 8104: ■ Beige.
- 9104: ■ Black.
- 8105: ■ Beige.
- 9105: ■ Black.



Ref.:9106



Ref.:9107

Ref.: 8106 BEIGE | Ref.: 9106 BLACK

F .. C ... S ... I ..

CLOSED PATELLA KNEE BRACE W/ SILICONE PAD & POLYCENTRIC REINFORCEMENTS

Ref.: 8107 BEIGE | Ref.: 9107 BLACK

F .. C ... S ... I ..

OPENED PATELLA KNEE BRACE W/ SILICONE PAD & POLYCENTRIC REINFORCEMENTS

SIZES	PERIMETER CM A	PERIMETER CM B
XS/1	36-39	26-29
S/2	39-42	29-32
M/3	42-45	32-35
L/4	45-48	35-38
XL/5	48-51	38-41
XXL/6	51-54	41-44
XXXL/7	54-57	44-47

A-Point of measurement: outline halfway up thigh
B-Point of measurement: outline halfway up calf

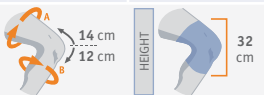

Incorporates lateral metallic reinforcements to improve medio-lateral stabilisation. These reinforcements have a polycentric articulation with a minimum flexion of 7 degrees to prevent hyperextension of the knee and to avoid genurecurvatum.

Characteristics:

Developed using three-dimensional knitted fabric, providing greater transversal elasticity at the same time as it exerts the necessary compression in each area, this new knitted fabric concept provides better hold on the skin and stability during movement, and does not require any fastening system, incorporates a visco-elastic cushion in ring form which manages the kneecap control, with blockage, in an upper and lower lateral sense.

Indications:

- Episodes of irritation (tendomyopathy, first phase ligamentosis, mild arthrosis, post-traumatic and post-operative arthritis).
- Sensation of instability (patellar and/or medio-lateral).
- Correction of mild genu-recurvatum; also indicated for the correction of varus-valgus of the knee, linked with instabilities of the knee.

Colours:

- 8106: Beige.
- 9106: Black.
- 8107: Beige.
- 9107: Black.



LOWER LIMBS



Ref.: SP110

F .. C S ... I .

PATELLAR KNEE BAND

SIZES

ONE SIZE



Compression, absorption and micro-massage effect are some of the improvements which we achieve thanks to the silicone cushion, contrary to other materials used previously.



Characteristics:

The patella support is made from velour and foam and incorporates a silicone ball which can be fastened and unfastened thanks to its micro-fastener adhesive.

Indications:

- Osgood-Schlatter disease.

Colour: ■ Maroon.



Exhibitor

Ref.: EXP-SP110

Units: 10

Sizes: 13 x 22 x 17 cm



MAIN FEATURES

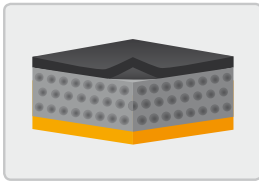

External layer of Lycra.
Intermedial layer of polyurethane foam.
Inner cotton material.

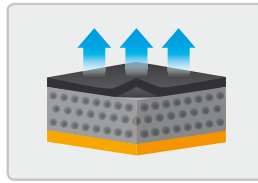

Breathable material which allows the airing of the skin, maintaining body temperature.

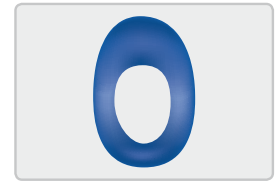

Some models include a silicone cushion which produces a micro-massage on soft parts of the joint.

LOWER LIMBS



Ref.: 6102 BEIGE | Ref.: 7102 BLACK

F ... C ... S ... I ...

SHORT KNEE BRACE W/ FLEXIBLE LATERAL REINFORCEMENTS

SIZES	PERIMETER CM	
XS/1	32-34	<p>Perimeter in cm around centre of kneecap</p>
S/2	34-36	
M/3	36-38	<p>HEIGHT 28 cm</p>
L/4	38-41	
XL/5	41-44	<p>POSSIBILITY TO CUSTOM-MAKE</p>
XXL/6	44-49	

Characteristics:

Fabric knee support in three layer breathable lycra material, polyurethane and cotton foam with open kneecap, with support, lateral stabilisers and adjustment straps.

Indications:

- Joint pain.
- Arthrosis and arthritis.
- Minor injuries.
- Minor contusions and mediolateral instabilities.

Colours:

6102: Beige.
7102: Black.



Ref.: 6103 BEIGE | Ref.: 7103 BLACK

F ... C ... S ... I ...

KNEE BRACE W/ FLEXIBLE LATERAL REINFORCEMENTS

SIZES	PERIMETER CM	
XS/1	32-34	<p>Perimeter in cm around centre of kneecap</p>
S/2	34-36	
M/3	36-38	<p>HEIGHT 35 cm</p>
L/4	38-41	
XL/5	41-44	<p>POSSIBILITY TO CUSTOM-MAKE</p>
XXL/6	44-49	

Characteristics:

Fabric knee support in three layer breathable lycra material, polyurethane and cotton foam with open kneecap, silicone cushion pad, lateral stabilisers, upper and lower adjustment straps and opening in the calf with Velcro fastener.

Indications:

- Joint pain.
- Arthrosis and arthritis.
- Tendonitis.
- Minor contusions and medio-lateral instabilities.
- The silicone pad produces an intermittent micro massage that favours re-absorption of oedemas and haematomas.

Colours:

6103: Beige.
7103: Black.



Ref.: 6103-A BEIGE | Ref.: 7103-A BLACK

F ... C ... S ... I ...

OPENED KNEE BRACE W/ FLEXIBLE LATERAL REINFORCEMENTS

SIZES	PERIMETER CM	
XS/1	32-34	<p>Perimeter in cm around centre of kneecap</p>
S/2	34-36	
M/3	36-38	<p>HEIGHT 35 cm</p>
L/4	38-41	
XL/5	41-44	<p>POSSIBILITY TO CUSTOM-MAKE</p>
XXL/6	44-49	

Characteristics:

Fabric knee support in three layer breathable lycra material, polyurethane and cotton foam with open kneecap, lateral stabilisers, upper and lower adjustment straps and full-length opening in the front.

Indications:

- Joint pain.
- Arthrosis and arthritis.
- Tendonitis.
- Minor contusions and mediolateral instabilities.
- The cushion produces an intermittent micro massage that favours re-absorption of oedemas and haematomas.

Colours:

6103-A: Beige.
7103-A: Black.



Ref.: 6104 BEIGE | Ref.: 7104 BLACK

F ... C ... S ... I ...

KNEE BRACE W/ POLYCENTRIC LATERAL REINFORCEMENTS

SIZES	PERIMETER CM	
XS/1	32-34	
S/2	34-36	
M/3	36-38	
L/4	38-41	
XL/5	41-44	
XXL/6	44-49	

Characteristics:

Fabric knee support in three layer breathable lycra material, polyurethane and cotton foam with open kneecap, silicone cushion pad, metallic plates with polycentric articulations and upper and lower adjustment straps.

Indications:

- Support, adjustment and stability.
- With the knee movement, the silicone pad produces an intermittent micro massage that favours re-absorption of oedemas and haematomas.

Colours:

6104: Beige.
7104: Black.



Ref.: 6104-A BEIGE | Ref.: 7104-A BLACK

F ... C ... S ... I ...

OPENED KNEE BRACE W/POLYCENTRIC LATERAL REINFORCEMENTS

SIZES	PERIMETER CM	
XS/1	32-34	
S/2	34-36	
M/3	36-38	
L/4	38-41	
XL/5	41-44	
XXL/6	44-49	

Characteristics:

Fabric knee support in three layer breathable lycra material, polyurethane and cotton foam with open kneecap, metallic plates with polycentric articulations and upper and lower adjustment straps full length opening in the front.

Indications:

- Joint pain.
- Arthrosis and arthritis.
- Tendonitis.
- Minor contusions and congenital or acquired medio-lateral instabilities.

Colours:

6104-A: Beige.
7104-A: Black.



Ref.: 6112 BEIGE | Ref.: 7112 BLACK

F ... C ... S ... I ...

SHORT ROM HINGED KNEE BRACE

SIZES	PERIMETER CM	
XS/1	32-34	
S/2	34-36	
M/3	36-38	
L/4	38-41	
XL/5	41-44	
XXL/6	44-49	

Characteristics:

Fabric knee support in three-layer breathable lycra material, polyurethane and cotton foam with upper and lower adjustment straps. Polycentric articulations of 0-15-30-60-90 degrees of flexion/extension, full-length opening in the upper front and lower back.

Indications:

- Postoperative and post-surgical treatment of the knee.
- Rehabilitation after injury.
- To obtain a range of control of the mobility of the operated knee (crossed ligament surgery).

Colours:

6112: Beige.
7112: Black.



Ref.: 6113 BEIGE | Ref.: 7113 BLACK

F ... C ... S ... I ...

LONG ROM HINGED KNEE BRACE

SIZES	PERIMETER CM	
XS/1	32-34	
S/2	34-36	
M/3	36-38	
L/4	38-41	
XL/5	41-44	
XXL/6	44-49	

Characteristics:

Knee support in three layer breathable lycra material, polyurethane and cotton foam with upper and lower adjustment straps. Polycentric articulations of 0-15-30-60-90 degrees of flexion-extension, full-length opening in the upper front and lower back.

Indications:

- Postoperative and post-surgical treatment of the knee.
- Rehabilitation after injury.
- To obtain a range of control of the mobility of the operated knee (crossed ligament surgery).

Colours:

6113: Beige.
7113: Black.



Ref.: 7117D RIGHT | Ref.: 7117I LEFT

F ... C ... S ... I ...

CONTROL KNEE BRACE W/LATERAL PAD

SIZES	PERIMETER CM
XS/1	32-34
S/2	34-36
M/3	36-38
L/4	38-41
XL/5	41-44
XXL/6	44-49

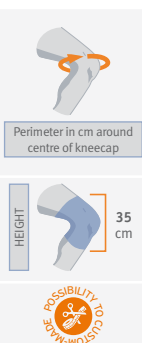

Characteristics:

Fabric knee support in three layer breathable lycra material, polyurethane and cotton foam. Flexible lateral stabilisers, open kneecap with semi-circular medial or lateral kneepad. Traction system by means of elastic straps and Velcro fastener that laterally wrap the kneecap.

Indications:

- External hyperpressure symptoms and in kneecap subluxations.
- Especially indicated to prevent (repetitive) relapses, after a surgical intervention of the external aileron section or of the relapsed luxation of the kneecap.

Colour: ■ Black.



Ref.: 6119 BEIGE | Ref.: 7119 BLACK

F ... C ... S ... I ...

WRAP AROUND KNEE SUPPORT WITH FLEXIBLE REINFORCEMENTS



Characteristics:

Knee support manufactured with breathable fabrics, open patella,, flexible lateral stays, popliteal opening and wrap-around closure system formed by 2 straps that are part of the knee support itself, wrapping around the thigh and calf, with a hook and loop closure. Incorporates the final tab closure for easy opening and closing.

Indications:

- Postsurgical knee treatments.
- Thanks to its design, this orthosis is indicated for use in those situations in which a quick fitting of orthosis is desired, or when a variation in the compression is required, depending on the activity (sport activities, in which compression is required for mechanical exertion, work activities, etc..).
- Patients with morphological deformities which would otherwise entail difficulties in orthosis fitting.

Colours:

- 6119: ■ Beige.
- 7119: ■ Black.



Ref.: 6120 BEIGE | Ref.: 7120 BLACK

F ... C ... S ... I ...

WRAP AROUND KNEE SUPPORT WITH POLYCENTRIC HINGES

SIZES	PERIMETER CM
S/1	32-36
M/2	36-41
L/3	41-49

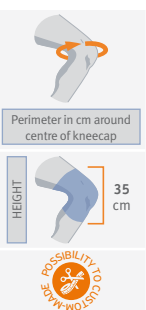

Characteristics:

Knee support manufactured with breathable fabrics, open patella, polycentric lateral hinges, popliteal opening and wrap-around closure system formed by 2 straps that are part of the knee support itself, wrapping around the thigh and calf, with a hook and loop closure. Incorporates the final tab closure for easy opening and closing.

Indications:

- Post-surgical knee treatments.
- Thanks to its design, this orthosis is indicated for use in those situations in which a quick fitting of orthosis is desired, or when a variation in the compression is required, depending on the activity (sport activities, in which compression is required for mechanical exertion, work activities, etc..).
- Patients with morphological deformities which would otherwise entail difficulties in orthosis fitting.

Colours:

- 6120: ■ Beige.
- 7120: ■ Black.

Ref.: TP-4500



Ref.: TP-4500C



Ref.: TP-4500 Ref.: TP-4500C SHORT

F

C

S

I

FABRIC THIGH SUPPORT WITH THERMOPLASTIC PLATES

SIZES	PERIMETER CM	HEIGHT CM	
		TP-4500	TP-4500C
XS/1	45-48	29	
S/2	48-52	24	
M/3	52-57		
L/4	57-64		
XL/5	64-71		

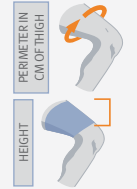

Characteristics:

Made from velour with a breathable Lycra lining, it features inner breathable honeycomb fabric pockets into which 2 mm-thick, low-density polyethylene thermoplastic plates are inserted (at the front and rear). Upper and lower velour straps for fastening with adjuster buckles and Velcro closure. Two models available depending on the height of the patient.

Indications:

- As a method of protection for patients undertaking work or sport-related activities while carrying certain injuries, such as 1st or 2nd degree fibrillar damage, minor tears and muscle strain.

Colour: Grey.

Ref.: TP-4800



Ref.: TP-4801



Ref.: TP-4800 Ref.: TP-4801
Tibia guard accessory

F

C

S

I

CALF SUPPORT WITH THERMOPLASTIC PLATES

Ref.: TP-4800

SIZES	PERIMETER CM	HEIGHT CM
XS/1	27-29	
S/2	29-32	
M/3	32-35	
L/4	35-39	
XL/5	39-43	

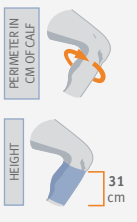

Characteristics:

Made from velour with a breathable Lycra lining, it features a breathable honeycomb fabric pocket at the rear into which a 2 mm-thick, low-density polyethylene thermoplastic plate is inserted. Zip opening system.

Tibia guard accessory Ref: TP-4801. The calf support can be fitted with a tibia guard accessory made from velour with inner honeycomb fabric into which a 2 mm-thick, low-density polyethylene thermoplastic plate is inserted and Velcro fastened. Upper and lower straps for fastening and adjustment.

Indications:

- As a method of protection for patients undertaking work or sport-related activities while carrying certain injuries, such as 1st or 2nd degree fibrillar damage, minor tears and muscle strain.

Colour: Grey.





Ref.: 94230
SHORT 51cm

Ref.: 94240
LONG 69cm

F ... C .. S I

KNEE ORTHESIS WITH FLEXION-EXTENSION JOINT

SIZES ONE SIZE

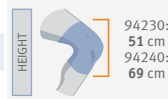

Characteristics:

Knee orthosis that comprises two foam corsets, two Velcro straps and polycentric articulations adjustable at 0-15-30-60 and 90° to limit the flexion/extension.

Indications:

- For unstable or injured knees.
- Post-operative and post-traumatic rehabilitation.
- For relative immobilisation of the articulation in situations that require perfect control.
- To obtain a range of control of the mobility of the operated knee (crossed ligament surgery).

Colour: ● Black.

Models:

- 94230: Short.
- 94240: Long.



Ref.: IR-4000 40cm

Ref.: IR-5000 50cm

Ref.: IR-6000 60cm

Ref.: IR-7000 70cm

F C ... S I

THREE PANELS KNEE IMMOBILIZER 0°

SIZES ONE SIZE



Characteristics:

Knee immobilizer with exterior velour fabric and interior cotton bouclé with lateral and rear shapeable plates. The three-panel adjustment system enables adaptation to different anatomies. With fastening straps in the interior panel to avoid sliding.

Indications:

- Pre and post-surgical knee treatment.
- After injury or fractures.
- Immobilisation of the entire leg and permanently maintaining the position.

Colour: ● Beige.



Ref.: IR-5001 (20°) / Ref.: IR-5002 (0°)

Ref.: IR-6001 (20°) / Ref.: IR-6002 (0°)

F C ... S I

KNEE IMMOBILIZER 0°/20°

SIZES	PERIMETER CM
S/2	24-32
M/3	32-40
L/4	40-46
XL/5	46-50

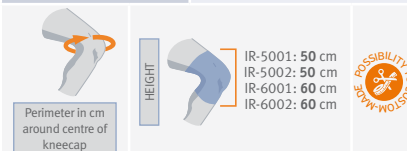

Characteristics:

Knee immobiliser made with external nylon that repels humidity and facilitates cleaning, with internal cotton bouclé, anatomical rear plate, lateral plates at 0° flexion and padded condylar supports.

Indications:

- Pre and post-surgical knee treatment where immobilisation is required with a certain degree of flexion.
- After injuries.

Colour: ● Blue.



Ref.: 94250 (4 Narrow bands, 4 Straps)

Ref.: 94251 (2 Wide bands, 4 Straps)

F ... C ... S I

F C ... S I

KNEE ORTHESIS WITH FLEXION-EXTENSION JOINT & LOCK SYSTEM

SIZES ONE SIZE

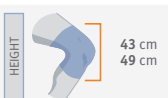

Characteristics:

Monocentric knee orthosis that comprises two adjustable foam belts and velour straps, with block in extension at 0° or for the control of flexion/extension from 0° to 80° in 10° intervals.

Indications:

- For unstable or injured knees.
- Postoperative and post-traumatic rehabilitation.
- For relative immobilisation of the articulation in situations that require perfect control.
- To obtain a range of control of the mobility of the operated knee (crossed ligament surgery).

Colour: ● Black.



Ref.: 94231

F ... C ... S ... I ...

ACTIVE KNEE BRACE ORTHOSIS

SIZES	PERIMETER CM
S/1	36-46
M/2	46-53
L/3	53-58



Perimeter in cm around centre of kneecap

The circumference measurement is taken 15 cm above the center of the patella



Characteristics:

Knee orthosis fitted with dual-axis polycentric joints, flexion-extension adjustment system and protective cover. Thigh and calf hemivalves in flexible thermoplastic with interior padding. Lined pads in the condylar area. The new design of the pins enables better fastening to the upper calf. The lower calf-level fastening strap is fitted with a silicone pad to increase the comfort and stability of the orthosis.

Indications:

- Anteroposterior and medial collateral knee instability and injuries, cruciate ligament injuries.
- Post-surgical treatment of the knee.

Colour: Black.



Ref.: 94260



Ref.: 94261

Ref.: 94260 (4 Narrow bands, 4 Straps)

F ... C ... S ... I ...

Ref.: 94261 (2 Wide bands, 4 Straps)

F ... C ... S ... I ...

ADJUSTABLE KNEE ORTHOSIS WITH LOCK SYSTEM

SIZES	ONE SIZE
	HEIGHT 44 cm 69 cm

Characteristics:

Knee orthosis with monocentric articulation. -10° to $+30^{\circ}$ locking system. 0° to 120° flexion control in intervals of 10° and -10° to $+30^{\circ}$ extension control in intervals of 10° . Ref.: 94260 has 2 femoral straps (thigh) and 2 tibia straps (calf), Ref.: 94261 has 2 wide strips which cover practically all the knee.

Indications:

- For unstable or lesioned knees.
- Post-operation and post-traumatic rehabilitation.
- For relative immobilisation of the articulation in situations which require perfect control.
- When we are interested in controlling the mobility of the post-operation knee (cruciate ligament surgery).

Colour: Black/Grey.



The mediolateral foam padded plates prevent the orthosis from rubbing against the leg, and are fitted with a fastening system with straps for adjustment.

Prolongation system using telescopic bars and friction clips to set the bar at the required height, from a minimum of 44 cm up to a maximum of 69 cm.



Pivoted fastening for improved dynamic adjustment

Lightweight aluminium alloy, similar to that used in the aviation industry

Slip-resistant lining for improved stabilisation during movement









Interior slip-resistant protective pads

Knee articulation with flexion and extension adjustment system

Air-filled condyle pads

Adjustable fastening straps

WEDGES

Flexion	Extension
 90°	 40°
 75°	 30°
 60°	 20°
 45°	 10° <small>PRE-FITTED</small>
	 0°



■ Fitting the stops

Adjustment of flexion and extension.

The orthosis is supplied with a set of stops to adjust flexion and extension.

- Select the desired stops.
- Unscrew the protective cover to enable the selected stop to be inserted.
- Once fitted, tighten the screw to fasten the cover and the stop. Repeat this process to adjust both the flexion and extension directions.





Ref.: OCR200D
RIGHT

Ref.: OCR200I
LEFT

F ... C .. S I ...

FUNCTIONAL KNEE ORTHOSIS WITH FLEXION-EXTENSION CONTROL - OCR200

SIZES	PERIMETER CM	
XS/1	34-41	
S/2	41-48	
M/3	48-55	
L/4	55-62	
XL/5	62-69	

Characteristics:

Made from low profile lightweight aluminium, it features dynamic polycentric joints with flexion and extension control and limitation. Non-slip interior lining to provide comfort and protection. The joints include air-cushioned condyle pads.

To adjust flexion and extension, it has galvanised steel wedges (to prevent corrosion) with different graduations.

Limitation range:

Extension: 0°, 10°, 20°, 30°, 40°.

Flexion: 45°, 60°, 75°, 90°.

The aluminium allows small individual adjustment.

Adjustment and fastening system by means of adjustable straps that include non-slip protection pads for a better fit.

Indications:

Collateral ligament injuries (tears), conservative treatment of instability resulting from combined knee injuries, ruptured cruciate ligaments combined with collateral ligament injuries (triad) and postoperative treatment after ligament surgery (ACL) and (PCL).

Colour: ■ Black.

Functions:

- Control of knee joint mobility.
- Mediolateral and valgus-varus stabilisation.
- Limitation of anteroposterior tibial slip (drawer effect).
- Control of hyper-extension and medial rotation.



ACCESSORIES



Ref.: OCR 204

AIR-CUSHIONED

Air-cushioned condyle pad for better protection with inflation system to regulate the compression level..

SIZES ONE SIZE

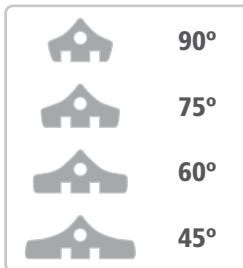

Ref.: OCR 205F

FLEXION STOP KIT

Includes bag with all flexion stops.

SIZES ONE SIZE

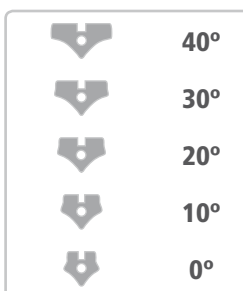

Ref.: OCR 205E

EXTENSION STOP KIT

Includes bag with all extension stops.

SIZES ONE SIZE

Genu Valgus

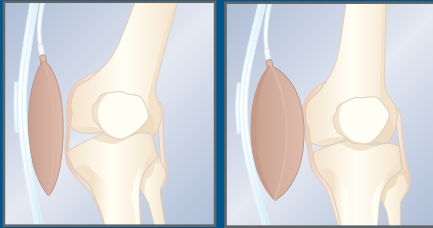

1

2

Genu Varus

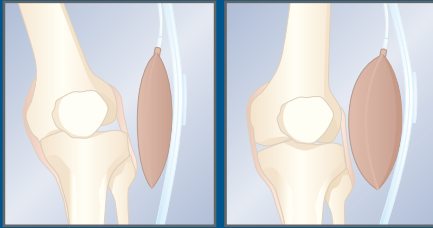

1

2

Important:
Model for choosing the right as the pathology look at this table.

Pathology:	Reference to selection:
Genu Varus Knee Support Right	6121 D (Right)
Genu Valgus Knee Support Right	6121 I (Left)
Genu Varus Knee Support Leftt	6121 I (Left)
Genu Valgus Knee Support Left	6121 D (Right)



LOWER LIMBS



Ref.: 6121D RIGHT | **Ref.: 6121I LEFT**

F ... **C** ... **S** ... **I** ...

VARUS-VALGUS KNEE SUPPORT

SIZES	PERIMETER CM	
XS/1	32-34	<p>Perimeter in cm around centre of kneecap</p>
S/2	34-36	
M/3	36-38	<p>HEIGHT 39 cm</p>
L/4	38-41	
XL/5	41-44	
XXL/6	44-49	

Characteristics:

Made from breathable elastic fabric, it comes with a polycentric articulation on one of the sides and flexible boning on the opposite side, condylar air cushion with valves and inflating system. Femoral and tibial closure for better adjustment, infrapatellar pad and front femoral opening for easy fitting.

Indications:

- Arthrosis of the tibio-femoral compartments.
- Arthrotic valgus and varus.
- Meniscal injuries.
- Gonarthrosis.

Colour: ■ Beige.

Keep in mind:

Right-handed version: right knee varus or left knee valgus. Left-handed version: left knee varus or right knee valgus.



When inflating the cushion, increase the medial or lateral compression for knee valgus or varus, in order to obtain an opening in the other tibio-femoral compartment, minimising condylar loads on the superior extremity of the tibia. The polycentric articulation, along with the inflatable cushion will contribute to an improved alignment. Open the tibiofemoral compartment in meniscal injuries.

MAIN FEATURES



Ref.: HO4001

F ••• C ••• S •••• I ••••

HIP STABILIZING ORTHOSIS

SIZES	WAIST CONTOUR	THIGH CONTOUR	CONTOUR
1	60-102	40-54	
2	90-132	50-64	

Characteristics:

Modular hip stabilizing orthosis that can be used interchangeably for the left or right hip. Made of high-density polyethylene. Comprised of a pelvic band and thigh support (both twin shell), connected by a joint that adjusts flexo-extension from 0° to 90° in increments of 10°, and abduction, in the 0°, 15° and 30° positions.

The thigh support allows you to modify the rotation and height of the condyle pad for a perfect fit. Both the pelvic band and the thigh support slide along the length of the joint splints in order to adapt them to the patient's height. The thigh support straps are made up of two velcro straps, and the pelvic band is adjusted using a Velcro belt.

The interior foam and external velour lining cover the plastic of the orthosis, protecting the patient from possible chafing from its rigid parts. These fabrics are easy to remove and wash, allowing for proper hygiene of the orthosis.

Indications:

- Post-op stabilization after full hip replacement.
- Complications after hip arthroplasty or dislocation.
- Post-reduction of dislocated or unstable prosthesis.
- After femoral head resection.
- Fractures.
- Poor bone quality (osteoporosis).

Colour: Grey.

ANATOMIC ASPECTS

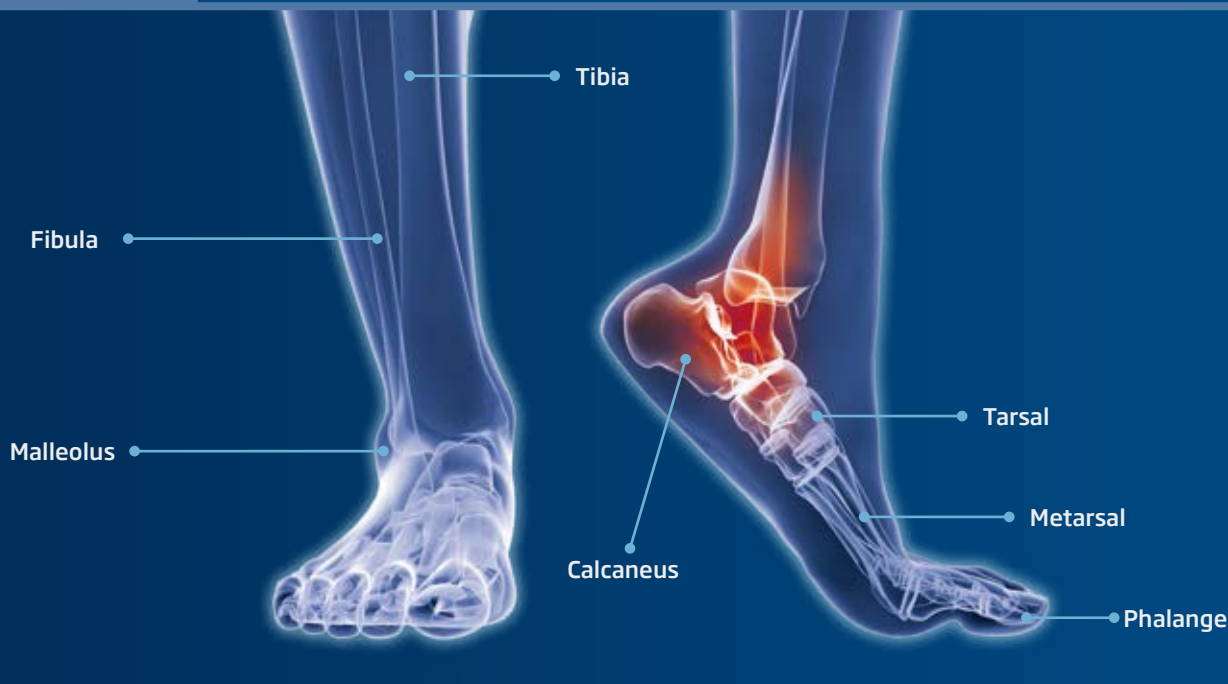

F Fastening **C** Compression **S** Stabilisation **I** Immobilization

LOWER LIMBS

Tobiplus® Orthesis for Ankle Control



MAIN FEATURES



An anatomical design to provide a precise and personalised fit for the patient.



Bilateral supports to provide natural stability without restricting the flexion and extension movements of the foot required for sport.



A system of straps designed to produce a tractive force in the desired direction, provide the necessary medio-lateral stability and enable the patient to adjust for a personalised fit.



Fonction:
Optimum medio-lateral stabilisation. A prevention and stabilisation method for acute and chronic ankle injuries. Ideal for certain sports (tennis, basketball, jumping etc.), which involve sudden starting and stopping movements that can lead to sprains or small fractures.

Ref.: EST-090

F ... **C** .. **S** ... **I** ...

LACE-UP STABILISING ANKLE SUPPORT

SIZES	PERIMETER CM
S/1	17-20
M/2	20-25
L/3	25-30



Characteristics:
An ankle stabilising orthosis made of highly resistant velour (FOAM) with a breathable interior lining (POROMAX®) and fitted with medial and lateral supports. A lace-up orthosis with a traction adjustment system and hook fastening. Medio-lateral stabilisation is provided by means of medio-lateral straps that control eversion and inversion movements by performing a taping function. Final fastening by means of an elasticated supramalleolar hook closure.

Indications:
Ankle injuries such as sprains, small fractures and post-traumatic acute ankle injuries. Post-surgery and as a method for preventing sporting injuries.

Colour: ■ Black.



MAIN FEATURES



It features anatomically designed medio-lateral stabilisers with an anti-rotational angle, providing excellent control of the eversion-inversion movements of the ankle and foot.



The rear strap enables individualised fitting and prevents both plates from slipping at moments of extreme biomechanical loads.



The varus correction strap provides rearfoot pronation, avoiding supination movements, which are the main cause of sprains and other sports-related injuries, and allowing the user to regulate the desired traction strength to obtain the necessary stabilisation level.



Ref.: EST-091D
RIGHT

Ref.: EST-091I
LEFT

F ... C .. S ... I ...

ANKLE BRACE WITH MEDIOLATERAL STABILISING SPLINT

SIZES	PERIMETER CM
S/1	17-20
M/2	20-25
L/3	25-30



Characteristics:

Manufactured in breathable velour and featuring mediolateral stabilisers at an anti-rotational angle to provide excellent protection. Its design and the materials with which it is manufactured allows it to be adapted to all types of footwear, providing comfort and safety at the same time. Its system of stabilising straps enables a personalised fit:

The rear strap enables individualised fitting and prevents both plates from slipping at moments of greater mechanical load. The varus correction strap provides the control required to prevent the supination movements that can cause sprains and other sports-related ankle injuries.

Indications:

Chronic ligament insufficiency (recurrent sprains), as a method of preventing sports-related injuries, in post-surgical rehabilitation and in grade 1 or 2 sprains.

Colour: ■ Black.

Orthosis for Ankle Control



Ref.: TOB-500B
BEIGE

Ref.: TOB-500N
BLACK

F .. C ... S .. I ..

CROSSOVER ELASTIC ANKLE SUPPORT

SIZES	PERIMETER CM
XS/1	<19
S/2	19-20
M/3	20-23
L/4	23-25
XL/5	>25



Characteristics:

Sock-type ankle support of soft and highly resistant elastic material and figure-of-eight elastic band.

Indications:

- Minor injuries.
- Luxations.
- As a precaution during sports activities.

Colours:

TOB-500B: ■ Beige.
TOB-500N: ■ Black.



Ref.: EST-084

F ... C .. S ... I ...

BREATHABLE ANKLE SUPPORT WITH THERMOPLASTIC PLATES

SIZES	PERIMETER CM
XS/1	<19
S/2	19-20
M/3	20-23
L/4	23-25



Characteristics:

Ankle stabiliser made in breathable semi-rigid fabric and designed to be able to opt for different indications, depending on the chosen configuration, as we can select from three types of components: conventional ankle support, ankle support with pronosupine webbing and ankle support with webbing and malleolar plates (internally and externally identified).

Indications:

- Conservative treatment in breakage of ankle ligaments.
- As postoperative protection in reconstructive ligament interventions.
- Injury of medial and lateral ankle ligaments.
- Chronic ankle instability.
- Post-operative rehabilitation. Tendinopathies.

Colour: ■ Blue.



Ref.: 8401 BEIGE Ref.: 9401 BLACK

F .. C ... S .. I ..

ELASTIC ANKLE SUPPORT WITH VISCOLASTIC PADS

SIZES	PERIMETER CM
XS/1	17-19
S/2	19-21
M/3	21-23
L/4	23-25
XL/5	25-27
XXL/6	27-29



Characteristics:

Developed in breathable elastic knitted fabric using flat weaving, it incorporates two anatomicallyshaped Viscolastic pads which redistribute the compression of the bandage from the protruding malleoli towards the fleshy parts around them.

Indications:

- Post-operative and post-traumatic irritation (e.g. after sprains).
- joint effusions and inflammations in the case of osteoarthritis and arthritis, tendinopathies, weak ligaments, prevention of sports or work-related injuries.

Colours:

8401: Beige.
9401: Black.



Reabsorption of oedemas, effusions, haematomas due to the compression effect of its fabric (pressotherapy). The pads distribute the compression towards the fleshy parts around the malleoli. The compression exerted by the elastic fabric and silicone pads provides support and stabilisation to the ankle joint.



Ref.: 2SSD RIGHT Ref.: 2SSI LEFT

Ref.: 1SSD RIGHT Ref.: 1SSI LEFT

“VALFEET AIR” INFLATABLE ANKLE STABILISING ORTHOSIS

“VALFEET XR” ANKLE STABILISING ORTHOSIS WITHOUT THE AIR CHAMBERS

F ... C ... S ... I ...

SIZES	FOOTWEAR SIZE
XS/1	35-37
S/2	38-40
M/3	41-43
L/4	44-46

Characteristics:

Stabilising orthesis to control the ankle, made up of two thermoplastic malleolar valves that are articulated with the sole support and inflatable malleolar linings for greater individualisation and stability. Includes 2 pads in the back of each strap area to prevent rubbing.

Indications:

- Post-injury immobilisation.
- Functional recovery. Instabilities.
- Prevention of sports injuries.
- Plantar fasciitis.

Colour: Black.



Ref.: CINCHA-VAL

Both Valfeet models incorporate the possibility of adapting a strap kit for treatments such as equinovarus foot, plantar fasciitis, etc.





Ref.: EST-085

F ... C ... S ... I ...

ANKLE SUPPORT

SIZES	FOOTWEAR SIZE
1	<36
2	≥36

Characteristics:

Bivalve ankle foot orthosis, in rigid thermoplastic, provided with an interior foam cushion with memory. Includes a regulating system on the ankle and a Velcro closure system for the medio lateral stabilisation and immobilisation of the tibio tarsal joint. Includes 2 pads in the back of each strap area to prevent rubbing.

Indications:

- Ankle sprains, tendonitis, post-operative ligaments of the ankle, such as prophylaxis on static alterations of the foot, especially from sports activities. Specially recommended for deltoid sprains, as well as sprains on anterior talofibular ligament, both which require a much longer recovery time.

Colour: ● Black.



Ref.: EST-082

F ... C ... S ... I ...

ANKLE ORTHOSIS WITH GEL

SIZES	ONE SIZE
-------	----------

Characteristics:

Bivalve ankle foot orthosis, in rigid thermoplastic, with inner memory-foam cushion and gel pads for cold therapy. The orthosis has been designed to allow use with the foam cushions alone or, if cold therapy is required, the gel pads can be inserted through the window in the foam cushion lining, which will adapt to accommodate them. The gel pads should be kept in the freezer for two hours beforehand. If the gel is used, we recommend removing the malleolar protection on the internal part of the valves. Includes 2 pads in the back of each strap area to prevent rubbing.

Indications:

- The indications of the EST-082 model are the same as those of the EST-085 when used without the gel pads. When these pads are used: Cold therapy, particularly during the practice of sports when an analgesic effect is required.

Colour: ● Black.

Leaf spring orthosis



Dismounted		Mounted	
Ref.: TP-2102D RIGHT	Ref.: TP-2102I LEFT	Ref.: TP-2102DM RIGHT	Ref.: TP-2102IM LEFT

LEAF SPRING ORTHOSIS

F • C • S ... I •

SIZES	FOOTWEAR SIZE	HEIGHT
S/1	35-37	29
M/2	37-39	32
L/3	39-41	34
XL/4	41-44	39

Characteristics:

The leaf spring orthosis is manufactured from injected high density polypropylene. Thanks to its design it allows elasticity at the Achilles heel level, permitting plantar flexion or dorsal flexion whilst walking, preventing the foot from falling, especially in the balancing stage, and maintaining the foot at 90°. The orthosis allows small adaptations and modifications, applying heat by way of a hot air pistol.

Indications:

- In general, patients affected by dorsal flexion limitation of the foot. Hemiplegia through vascular-cerebral accidents (ictus), flaccid palsy sequelae.
- Retraction of the Achilles heel in infantile cerebral palsy.
- External popliteal sciatic nerve lesions.
- This orthosis is not for use in patents with varus or valgus deviations of the rear foot, and spastic palsy.

Colours: ○ White.



Ref.: KIT-TP 2102

LEAF SPRING ORTHOSIS KIT

The individual orthosis assembly kit can be ordered with Ref.: KIT-TP 2102, for which there are two sizes:

- Small size (for sizes 1 and 2 of the Anti-equine).
- Large size (for sizes 3 and 4 of the Anti-equine).

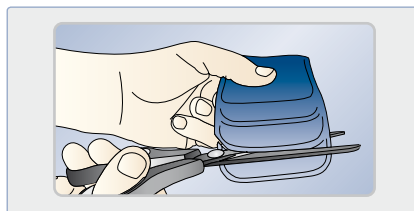

The interior tibial protection cushion can be cut to the desired size, thanks to the marks along its length.

MAIN FEATURES

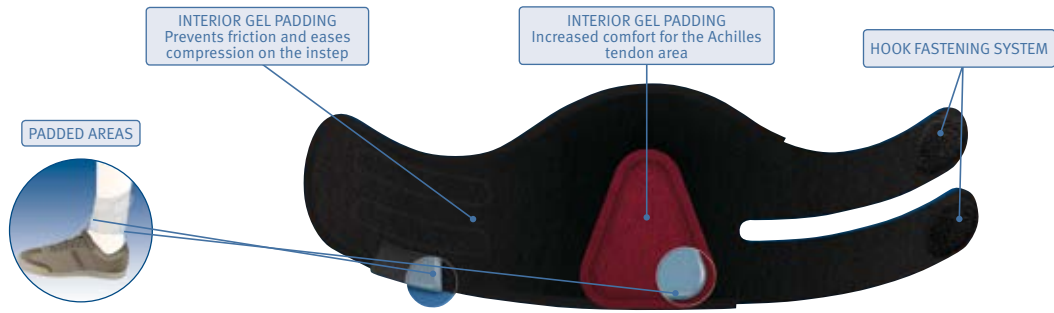

The Boxia® drop-foot support raises the forefoot, allowing plantarflexion at the heel, when stepping off the foot. It prevents the risk of trips over everyday items, such as rugs, kerbs and irregular surfaces.

LOWER LIMBS



Ref.: AB01

F ... C ... S ... I ...

BOXIA A.F.O.-DROP FOOT

Characteristics:

The Boxia® device consists of 2 separate parts: a support above the ankles and a non-slip support section to put between the tongue and shoelaces via a central hook type attachment (must be worn with laced shoes). Both parts are linked by an elastic strap which is adjustable according to how much bending is required. The back of the strap has interior gel padding for comfort on the Achilles tendon, while the instep area is lined to prevent unwanted friction and ease compression.

Indications:

- Flacid paralysis.

Benefits:

Discreet, comfortable and flexible. It occupies little space in the shoe and is easily adjusted.

Colours:

- AB01: ● Black.
- AB02: ● Beige.

SIZES	PERIMETER CM
XS/0	13-17
S/1	17-21
M/2	21-25
L/3	25-29

Above malleolus

How it works:

The Boxia® drop-foot support raises the forefoot, allowing plantarflexion at the heel, when stepping off the foot. It prevents the risk of trips over everyday items, such as rugs, kerbs and irregular surfaces.

SEE HOW IT WORKS ON THE DEMONSTRATION VIDEO:
www.orliman.com





Ref.: AB14

CALF SUPPORT FOR THE BOXIA DROP FOOT ANKLE BRACE



Characteristics:

The Boxia drop foot ankle brace's supramalleolar support stores a large amount of energy, similar to a pivot (support point), to enable it to transfer the necessary forces to lift a paralysed foot. In cases in which a patient shows intolerance due to excessive force, the Boxia calf support is recommended. It helps to stabilise the orthosis and restrict forces and stresses by transferring them from the ankle to the calf.

Indications:

- Flacid paralysis.

Colours:

- AB14: ● Black.
- AB24: ● Beige.

SIZES AB01	SIZES AB14
XS/0	XS/0
S/1 - M/2	S/1
L/3	M/2

Equivalences for chose the correct size.

• Easy to fit getting better stabilitation •

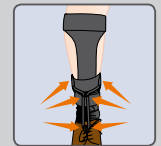
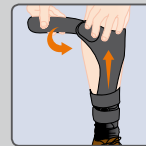
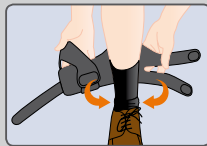
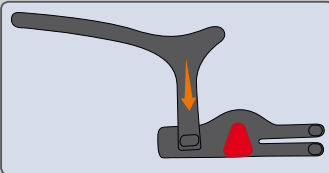

Ref.: AB12D RIGHT | **Ref.: AB12I LEFT**

TO ADAPT TO AB01 (NOT INCLUDED)

INTERIOR ARCH SUPPORT

SIZES	PERIMETER CM
S/1	17-21
M/2	21-25
L/3	25-29



Characteristics:

Anatomically designed to the shape of either the left or right foot, for supporting the arch area with padding. Reference AB12 contains only the lower part for the foot. You must therefore already have part Ref: AB01 (Boxia dropfoot support).

Colours:

- AB12D/ AB12I: ● Black.
- AB22D/ AB22I: ● Beige.

ACCESSORIES



Ref.: AB13

“S”-SHAPED HOOKS FOR BOXIA (2 UNITS)

SIZES ONE SIZE



Ref.: AB10

BOXIA TRACTION ELASTIC (1 UNIT)

SIZES 1 2 3

Same sizes as for Ref: AB01.

Colours:

- AB10: ● Black.
- AB20: ● Beige.



Ref.: AB11

BOXIA ATTACHMENT HOOK (2 UNITS)

SIZES ONE SIZE

Colours:

- AB11: ● Black.
- AB21: ● Beige.

Orthesis for Ankle Control



Ref.: TP-2100

F .. C . S I

MULTI-POSITIONAL FOOT-ANKLE SPLINT

SIZES	FOOTWEAR SIZE
S/1	<32
M/2	32-38
L/3	39-44
XL/4	>44

Characteristics:

High-density polyethylene splint with internal or external regulation from 0° to 15°. The splint incorporates a system that allows us to regulate plantar and dorsal flexion over a 75° range in 15° intervals. The internal lining is bouclé in washable breathable cotton. Its fastening system comprises Velcro webbing with protection pads. Can be adapted to both the left and right foot.

Indications:

- Post-operative therapy of the knee, hip and foot, whenever rotation control of the lower member is necessary (neutral position, internal or external rotation).
- As a splint for the positional control of the lower extremity in patients bed-ridden for long periods of time (intensive care unit).
- As a system to prevent deformities in bedridden patients (prevention).
- Hemiplegia.
- Paralysis of lower member.
- Chronic pain of the plantar fascia (plantar fasciitis).

Colour: White.



Ref.: TPA-2100.1

ACCESSORY ON MULTI-POSITION SPLINT FOR ACTIVE REHABILITATION

SIZES	ONE SIZE

Characteristics:

With the active rehabilitation guide, the splint allows us to make plantar flexion movements against a resistance and the dorsal flexion thanks to the elastic strap, where the resistance can be adjusted to a higher or lower tension.

Colour: Black.

Walkers by Orliman® Ankle Immobilizing Orthosis



Ref.: EST-088

Ref.: EST-087
LONG

Ref.: EST-088
SHORT

F C .. S I

WALKER FIXED

Ref.: EST-087

SIZES	FOOTWEAR SIZE	INCHES		HEIGHT
		FEMALE	MALE	
S/1	36-39	5-8	4-7	38
M/2	40-42	9-10	7½-9	42
L/3	43-45	10½-12	9½-11	42

Characteristics:

A single piece, light, resistant design with open heel and fastening straps for circumference compression. Transpirable material covering pad for the leg, foot and ankle, tibia and calf protection plates. Low-profile sole in the form of a slip-proof balance.

Indications:

- Protection and control following traumatism or surgical intervention, sprain and ligament injury, as a method to replace plaster in the treatment of preulcerous or ulcerous conditions of the foot's plantar surface.
- Acute plantar fasciitis and in those cases which require a uniform distribution of body weight on the plantar surface and immobilisation of the tibia-tarsus articulation.

Colour: Black.

Ref.: EST-088 SHORT

SIZES	FOOTWEAR SIZE	INCHES		HEIGHT
		FEMALE	MALE	
S/1	36-39	5-8	4-7	27
M/2	40-42	9-10	7½-9	27
L/3	43-45	10½-12	9½-11	27



Ref.: EST-086

F C . . . S I

ROM WALKER

SIZES	FOOTWEAR SIZE	INCHES		HEIGHT
		FEMALE	MALE	
S/1	36-39	5-8	4-7	36
M/2	40-42	9-10	7½-9	42
L/3	43-45	10½-12	9½-11	42

Characteristics:

Light, resistant design. Has a transpirable material covering pad for the leg, foot and ankle. Slip proof, low-profile sole in the form of a balance, attached to monocentric articulations with 0 to 45° flexoextension regulation system and medial and lateral props, tibia and calf protection plates.

Indications:

- Protection and control following traumatism or surgical intervention, sprain and ligament injury, as a method to replace plaster in the treatment of preulcerous or ulcerous conditions of the foot's plantar surface.
- Acute plantar fasciitis and in those cases which require a uniform distribution of body weight on the plantar surface and immobilisation of the tibia-tarsus articulation.

Colour: ■ Black.



Ref.: EST-083

F C . . . S I

ROM AIR WALKER

SIZES	FOOTWEAR SIZE	INCHES		HEIGHT
		FEMALE	MALE	
S/1	36-39	5-8	4-7	36
M/2	40-42	9-10	7½-9	42
L/3	43-45	10½-12	9½-11	42

Characteristics:

Light, resistant design. Has a transpirable material covering pad for the leg, foot and ankle with an airbag, inflation pump and regulation valve. Slip proof, low-profile sole in the form of a balance, attached to monocentric articulations with 0 to 45° flexoextension regulation system and medial and lateral props, tibia and calf protection plates.

Indications:

- Protection and control following traumatism or surgical intervention, sprain and ligament injury, as a method to replace plaster in the treatment of preulcerous or ulcerous conditions of the foot's plantar surface.
- Acute plantar fasciitis and in those cases which require a uniform distribution of body weight on the plantar surface and immobilisation of the tibia-tarsus articulation.

Colour: ■ Black.



Ref.: AW01

WEDGES FOR WALKERS (WEDGE FOR ACHILLES TENDON)

SIZES	FOOTWEAR SIZE
S/1	36-39
M/2	40-42
L/3	43-45

Characteristics:

During treatment with a Walker (ankle orthosis), and if the patient requires Achilles tendon repair, it is necessary to adjust the brace so that the foot is approximately at 20° of plantar flexion.

As plantar reduction is progressive, a set of ergonomically-designed wedges are needed to reduce plantar flexion from 22° to 0° at intervals of 22°, 16°, 10° and 0°.

To facilitate this, Orliman has designed a set of three 2-cm wedges and a heel cup that are joined together by removable adhesive, enabling easy assembly and separation.

Colour: □ White ■ Blue.

Units: 1.



TECHNICAL CHARACTERISTICS

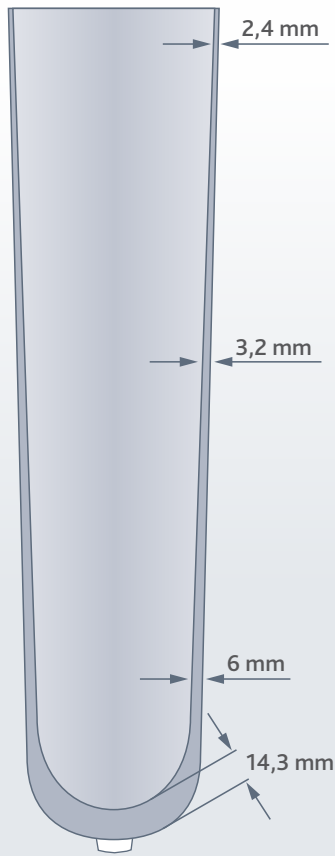

► Extra thickness of smooth silicone.

Technical data

Material Medical silicone

Length Aprox. 39 cm

Matrix

The matrix, designed to increase the stability of the distal tissues, thereby minimising the risks of injuries and providing maximum comfort, is located in the distal region. This distal reinforcement tissue limits the elongation and its subsequent piston effect when walking. Orliman liners have a 10 cm matrix that provides the necessary stability whilst limiting longitudinal stretching of the soft tissues of the stump when walking, especially during the balancing phase in which the prosthesis is fully suspended with a pendular movement.

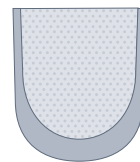

► 10 cm matrix.

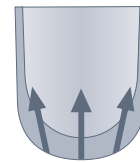

► Increased stability.

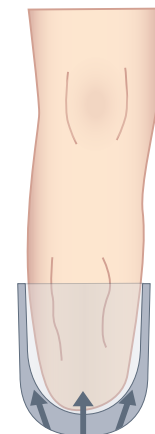

► Maximum comfort.

MAIN FEATURES



Distal cushioning

In order to increase the patient's skin comfort and care, especially in the scar region, the distal extreme of the liner is cushioned with an extra thick layer of soft silicone to provide the cushioning required to adapt to irregular scars, reducing rotational moments and distal impacts during loading.



Outer lining

The silicone liner has a textile lining in circular woven fabric provide a high strength lining that gives the liner long-term durability and absorbs the friction between the silicone and the rigid fitting, making it easier to put on and take off the prosthesis.



Medical silicone

High strength and easy to clean.



SOFT

Model indicated for patients with low to moderate activity.



ACTIVE

Model indicated for highly active patients.

Ref.: LI1001

SILICONE TIBIAL LINER WITH PIN. SOFT

Ref.: LI1002

SILICONE TIBIAL LINER WITH PIN. ACTIVE.

SIZES CM	20	22	23,5	25	26,5	28	30	32	34	36	38	40
----------	----	----	------	----	------	----	----	----	----	----	----	----

Characteristics:

Different densities are available depending on the patient's activity, thus providing the resistance and comfort demanded by amputees with different activities and characteristics.

Indications:

Indicated for patients with tibial amputations.

Properties:

- Manufactured in medical silicone.
- Matrix of 10 cm to stabilise the distal soft tissues.
- Distal umbrella designed to distribute the forces over the entire surface. Universal screwed orifice that allows it to be adapted to all kinds of suspension systems. (Shuttle locks).

Size selection:

Size selection is extremely important as an incorrect size could cause sweating and lack of precision when adapting the prosthesis and when walking; the stabilising matrix and distal umbrella should remain perfectly adapted to the stump. For this reason, Orliman has a broad range of sizes, from 20 up to 40 cm, to meet the requirements of different tibial stump morphologies.

For selection of the correct size measure on the patient's stump 4 cm proximally from the distal end. Then, select a size less than the measurement obtained and try it on the patient for them to check it before casting. A liner two sizes smaller is recommended for amputees undergoing their first prosthetisation in anticipation of fast stump shrinkage and possible liner displacement.

Colour: ■ Blue.

FUNCTIONS OF THE LINERS

Silicone has the property of adhering closely to the skin and this manages to avoid irritations resulting from rubbing, dispersing the pressure areas from bone areas with the rigid laminated fitting. Because of its compression system it acts as a method to reduce oedema, while more specifically its functions are:

- Cushioning of sensitive areas and exostosis.
- Protection of skin, scars, etc.
- Cushioning of the impacts produced in the load area during the support phase when walking.
- Improved venous return by acting as a distal compression system.
- Stabilisation of the soft tissues of the stump, especially at the distal extreme.
- Balanced distribution of compression forces on the surface of the stump.
- Minimisation of the pressures in the distal region of the stump, providing padding for total contact fixings.
- As a prosthesis suspension method thanks to its combination with shuttle locks or similar systems.
- Reduction of the piston effect when walking.



ORLIMAN LINERS

Silicone liners for tibial prostheses



Model indicated for patients with low to moderate activity.

Model indicated for highly active patients.

Ref.: LI1003

Ref.: LI1004

SILICONE TIBIAL LINER WITHOUT PIN. SOFT.

SILICONE TIBIAL LINER WITHOUT PIN. ACTIVE.

SIZES CM	20	22	23,5	25	26,5	28	30	32	34	36	38	40
----------	----	----	------	----	------	----	----	----	----	----	----	----

Characteristics:

Different densities are available depending on the patient's activity, thus providing the resistance and comfort demanded by amputees with different activities and characteristics.

Indications:

Indicated for patients with tibial amputations.

Properties:

Manufactured with high strength and easy to clean medical silicone. With a 14.3 mm distal pad for comfort and care of the patient's skin with an extra thickness of smooth silicone for extra cushioning, adapting to irregular scars, reducing rotational moments and distal impacts during loading. The outer sleeve of the liner is made of a circular knit fabric, providing it with a high strength coating that gives the liner prolonged durability and absorbs friction between the silicone and the fitting. In the distal zone is the matrix, the function of which is to increase the stability of the distal soft tissues, minimising the risk of injury and providing maximum comfort. To ensure proper function of the liner without pin in tibial prostheses, we recommend the use of the suspension system Orliman Ref: LI1005, composed of a Lycra-coated silicone knee brace.

Colour: ■ Blue.

ORLIMAN Sleeves



Ref.: LI1005

SUSPENSION SYSTEM FOR TIBIAL PROSTHESES

SIZES	PERIMETER CM
1	45-48
2	48-52
3	52-57
4	57-64

PERIMETER IN CM OF THIGH



SIZES LI1005	SIZES LINERS
1	20-23,5
2	25-28
3	30-34
4	36-40

As guidance we have included a box with sizes of LINERS so that it is possible to know the correspondence with the suspension system.

Characteristics:

Lycra-coated silicone suspension system for tibial prostheses. Being made of silicone, it adheres to both the hard fitting of the prosthesis and the patient's thigh, providing a perfect fit between socket and stump and avoiding a sliding effect from the prosthesis. It also prevents the entry of air through the proximal part of the fitting, managing to maintain the vacuum required for the proper functioning of the prosthesis. The elasticity of the materials used allows great freedom of movement, even in knee flexion.

Properties:

The Orliman tibial suspension system provides the necessary adjustment for proper function of the tibial prosthesis; as it is made from silicone it grips the thigh as required in order to keep the prosthesis properly fitted. This, coupled with not allowing the entry of air through the proximal part of the fitting, prevents against sliding, thus reducing the friction between the stump and the hard fitting and protecting the stump against possible injury due to friction.

Colour: ■ Beige.



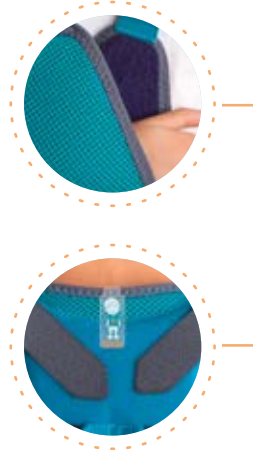

› Ever since the beginning...

Since Orliman was founded, the company has been involved in the manufacture of made-to-measure orthoses for children at the request of orthopaedic specialists, because no quick solutions for children's injuries or conditions had previously existed.

› The challenge of making it possible

From a biomechanical and design perspective, working with children is based on the same orthopaedic principles as working with adults. In fact, our range of pediatric orthoses includes very few systems that are specifically designed for pediatric applications.

Aware of this need and based on extensive experience, Orliman, in conjunction with its R&D department and in collaboration with technicians and specialists in pediatric medicine, has developed a new line:

Orliman® Pediatric.



This line was created to offer products to treat common childhood injuries and conditions, and utilises comfortable materials with designs and functionality to suit younger users.

› Aim

Our aim is to ensure that children do not have to stop playing, jumping and running, but can continue with their daily activities, and there is no greater satisfaction for the team at Orliman than when this is made possible.

Orliman Pediatric is a product line that features supports for the knee, ankle, wrist, neck, etc., and other more technical devices that can help to prevent and/or correct, protect and immobilise. In short, products that provide relief and ensure a quick recovery for the child.

For us, making this possible means that children can continue to do what they have always enjoyed doing: "Playing without limits".





Ref.: OPH101

CRANIAL PROTECTION HELMET



SIZES PERIMETER CM	AGE MONTHS
40	0-3
42	3-6
44	6-9



Characteristics:

The pediatric cranial protection helmet is made from breathable padded foam and has an interior terrycloth lining and honeycomb fabric covering, providing great strength and durability. The helmet is fastened by means of a chin strap that contains neoprene padding to prevent discomfort and chafing and features a simple plastic adjuster buckle to enable its length to be adjusted to fit the physical characteristics of each patient.

Indications:

- Cerebral palsy.
- Patients with epilepsy.
- Neuromuscular disorders that cause loss of balance.
- Babies with craniums that are not yet fully formed.
- After an operation as protection against knocks.
- Spasticity and in all cases where there is a risk of cranial contusions.

Colour: Green.



Ref.: CC2106

PEDIATRIC CERVICAL COLLAR



SIZES	PERIMETER CM
S/1	23-28
M/2	29-34



Characteristics:

Manufactured in 6 cm-wide polyurethane foam, posterior Velcro closure, breathable and anatomical design. 100% cotton outer cover. Orliman's pediatric cervical collar has been specifically manufactured for infants and features a design that perfectly adapts to the physical characteristics of these patients.

Indications:

- Mild trauma of bony (spinous and transverse processes) and soft (whiplash) parts of the body.
- Postoperative patients, torticollis, cervical pain and compressive syndromes.

Colour: Grey.



Ref.: OP1130

CLAVICLE IMMOBILISER



SIZES	AGE	PERIMETER CM
1	2-6	48-58
2	6-12	58-72



Characteristics:

Made from honeycomb fabric, terrycloth and padded foam with neoprene covers on the straps, adjuster buckles at the back and Velcro fasteners to adjust the tension of the orthosis. The Velcro fasteners can be removed if necessary to shorten the length of the strap to fit the physical characteristics of each patient. The back pad is made from padded material to improve patient comfort. The straps are made from rigid velour to enable proper immobilisation of the shoulders in retropulsion.

Indications:

- Clavicle fracture treatments to align fractured segments, such as figure-8 bandaging. Posture reminder.

Colour: Green and grey.



Ref.: OP1131

SHOULDER IMMOBILISING PEDIATRIC SLING



SIZES	AGE	LENGTH
1	2-6	<23
2	6-12	30

LENGTH IN CM OF FOREARM



Characteristics:

Made from breathable honeycomb fabric and terrycloth, this elbow and forearm sling features Velcro fasteners that enable the length of the strap to be adjusted to fit the requirements of each patient. The strap has cushioned padding to protect the patient from uncomfortable pressure on the neck and shoulder. It also features an adjustable waist band, which, once closed, immobilises the shoulder joint.

Indications:

- Post-operative or post-traumatic immobilisation treatment.
- Shoulder and arm injuries that require reduced mobility for treatment.
- Soft tissue injuries, such as infections or burns.
- Shoulder subluxations.

Colour: Green and grey.



Ref.: OP1132

PEDIATRIC SLING



SIZES	AGE	LENGTH
1	2-6	<23
2	6-12	30

LENGTH IN CM OF FOREARM



Characteristics:

Made from breathable honeycomb fabric and terrycloth, this elbow and forearm sling features Velcro fasteners that enable the length of the strap to be adjusted to fit the requirements of each patient. The strap has cushioned padding to protect the patient from uncomfortable pressure on the neck and shoulder.

Indications:

- Post-operative or post-traumatic immobilisation treatment.
- Shoulder and arm injuries that require reduced mobility for treatment.
- Soft tissue injuries, such as infections or burns.

Colour: Green and grey.



Ref.: OP1133

PEDIATRIC ARM SLING



SIZES	ONE SIZE

Characteristics:

The arm sling consists of a forearm support attached to a strap that passes around the back of the neck. The support is made from breathable honeycomb and terrycloth fabric and the strap is made from a padded textile material. The length of the strap can be adjusted with a simple Velcro fastener. The strap is designed to adopt an anatomical shape, which helps to relieve discomfort from pressure at the back of the neck.

Indications:

- Post-operative or post-traumatic immobilisation treatment.
- Shoulder and arm injuries that require reduced mobility for treatment.
- Soft tissue injuries, such as infections or burns.

Colour: Green and grey.



Ref.: OP1154

PEDIATRIC WRIST SUPPORT



SIZES	ONE SIZE

Characteristics:

Wrist support made from breathable honeycomb fabric and elastic velour, featuring Velcro straps for fastening to enable compression to be adjusted to fit the needs of each patient.

Indications:

- Prevention of wrist injuries.

Colour: Green and grey.



Ref.: OP1152 RIGHT

Ref.: OP1153 LEFT

IMMOBILISING WRIST SUPPORT



SIZES	AGE	PERIMETER CM	LENGTH CM
1	2-6	10-12	12
2	6-12	12-15	14



Characteristics:

Pediatric wrist support made from honeycomb fabric on the inside and velour on the outside (both breathable and washable materials), featuring a malleable aluminium palmar splint, which immobilises the wrist joint in a functional position, and a splint located on the back, which provides the support with sufficient rigidity to immobilise the wrist joint.

Indications:

- Immobilisation and protection of the carpometacarpal and metacarpophalangeal joints. Conservative treatment after surgery or injury.

Colour: Green and grey.



Ref.: OP1155

THUMB ATTACHMENT FOR IMMOBILISING WRIST SUPPORTS



SIZES	AGE
1	2-6
2	6-12

Characteristics:

This attachment consists of a malleable aluminium splint covered with terrycloth and velour fabric and featuring Velcro tabs that adhere to the pediatric splint in order to immobilise the thumb joint and keep it in a certain position.

Colour: Green and grey.

Ref.: OP1150 RIGHT
Ref.: OP1151 LEFT
WRIST, HAND AND FINGER IMMOBILISING SPLINT

SIZES

ONE SIZE

Characteristics:

Immobilising splint for the wrist, hand and fingers, including the thumb, specifically designed for infant patients. It features a malleable aluminium core that enables the splint to be adapted and positioned to fit the needs of each patient. Inner foam padding and outer velour covering. The position of the wrist, hand and fingers can be changed as per medical requirements. The possibility exists of using a digital attachment to enable separation and alignment of the fingers (universal size).

Indications:

- Neurological injuries of central or peripheral origin.
- Disorders that require immobilisation of the wrist joint, hand and fingers to enable treatment.

Colour:  Black and grey.

Ref.: OP1140
PEDIATRIC ELBOW SUPPORT

SIZES	AGE	PERIMETER CM
1	2-6	16-19
2	6-12	19-22

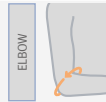
Characteristics:

Pediatric elbow support made from breathable honeycomb fabric on the inside and terrycloth on the outside and featuring a fastening strap. Velcro closure located on the front.

Indications:

- Minor elbow injuries.
- Tendinitis.
- Containment after removal of a plaster cast.

Colour:  Green and grey.

Ref.: OP1141
ELBOW IMMOBILISER WITHOUT FLEXION

SIZES	AGE	PERIMETER CM
1	2-6	13-16
2	6-12	16-23

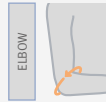
Characteristics:

Made from terrycloth on the inside and honeycomb fabric and velour on the outside, breathable, rigid aluminium splints on the back and sides, fastening by means of Velcro straps.

Indications:

- Pediatric patients that require treatment involving a peripheral venous access device.
- Orliman's elbow immobilising orthosis keeps the elbow joint immobilised in extension.

Colour:  Green and grey.

Ref.: OP1160
UMBILICAL TRUSS
SIZES

ONE SIZE

Characteristics:

Orliman's Pediatric umbilical truss is made from padded and breathable Lycra-velour foam. The truss is wider at the front and contains a round silicon pad which presses on the hernia to ensure it is contained.

Indications:

- The disorder is benign and caused by incomplete closure of the navel.
- The pediatric umbilical truss enables the condition to be corrected by containing the umbilical hernia and ensuring that the section of protruding intestine remains inside the abdominal wall.

Colour:  Beige.

Ref.: OP1180
KNEE IMMOBILISER

SIZES	AGE	PERIMETER CM
1	2-6	24-30
2	6-12	30-36

Perimeter in cm around centre of kneecap

Characteristics:

Orliman's knee immobilising orthosis is made from terrycloth on the inside and breathable honeycomb fabric on the outside. It features side splints and a rear splint to keep the leg immobilised in extension. The side splints can be set to two positions to fit the physical characteristics of each patient (they have to be parallel to the knee joint). The orthosis is fastened at the front with Velcro straps.

Indications:

- Disorders whose treatment requires immobilisation of the knee joint.
- Pre and postoperative knee treatment.
- After injuries or fractures.

Colour:  Green and grey.

Ref.: OP1181
PEDIATRIC KNEE BRACE WITH SIDE STABILIZERS

SIZES	AGE	PERIMETER CM
1	2-6	20-26
2	6-12	26-32

Perimeter in cm around centre of kneecap

Characteristics:

Knee brace made from breathable honeycomb fabric on the inside and velour on the outside (both elastic), featuring spiral side stays that provide the knee joint with slight stabilisation in the medial-lateral direction. Fastening is by means of two Velcro straps located at the top and bottom of the knee brace. The front part features an open kneecap. The brace comes in the colour grey with green side bars and green outer stitching, providing the orthosis with an infant unisex look. The compression of the brace can be adjusted using the Velcro straps. The materials from which it is made enable the brace to be washed to ensure proper hygiene. It comes in two sizes and can be used on either the right or left leg.

Indications:

- Mild bruising.
- Patellofemoral injuries.
- Postoperative treatment.
- Mild instability of the knee joint.
- Rehabilitation.
- Any knee condition that requires centring or unloading of the patella.

Colour:  Green and grey.

Ref.: OP1182
ARTICULATED PEDIATRIC KNEE BRACE

SIZES	AGE	PERIMETER CM
1	2-6	20-26
2	6-12	26-32

Perimeter in cm around centre of kneecap

Characteristics:

Knee brace made from breathable honeycomb fabric on the inside and velour on the outside (both elastic), featuring a polycentric joint to stabilise the knee in the medial-lateral direction. Fastening is by means of two Velcro straps located at the back that enable compression to be adjusted. The front part features an open kneecap. The brace comes in the colour grey with green side bars and green outer stitching, providing the orthosis with an infant unisex look. It comes in two sizes and can be used on either the right or left leg.

Indications:

- Mild bruising.
- Patellofemoral injuries.
- Postoperative treatment.
- Medio-lateral instability.
- Rehabilitation.
- Any knee condition that requires centring or unloading of the patella.

Colour:  Green and grey.

Ref.: OP1183
PADDED KNEE BRACE

SIZES	AGE	PERIMETER CM
1	2-6	20-26
2	6-12	26-32

Perimeter in cm around centre of kneecap

Characteristics:

Knee brace made from breathable honeycomb fabric on the inside and velour on the outside (both elastic), featuring a pad at the front to protect the knee against possible bruising from knocks. Fastening is by means of two Velcro straps located at the back of the knee brace.

Indications:

- In processes requiring heat and compression.
- Injuries.
- Postoperative treatment.
- Protection against possible bruising from knocks.

Colour:  Green and grey.

Ref.: OP1184
PEDIATRIC PALUMBO KNEE BRACE

SIZES	AGE	PERIMETER CM
1	2-6	20-26
2	6-12	26-32

Perimeter in cm around centre of kneecap

Characteristics:

Knee brace made from breathable honeycomb fabric on the inside and velour on the outside (both elastic), featuring flexible spiral side stays, open kneecap with lateral patella pad in the shape of a semi-circle and traction system by means of Velcro straps that embrace the patella laterally, thereby stabilising the knee joint.

Indications:

- External hyperpressure syndrome and patella subluxation.
- After surgery on the lateral retinaculum or recurrent dislocation of the patella.

Colour:  Green and grey.

Ref.: OP1190
ANKLE SUPPORT

SIZES	AGE	PERIMETER CM
1	2-6	20
2	6-12	24

ABOVE MALLEOLUS

Characteristics:

Elastic and breathable ankle support made from honeycomb fabric on the inside and velour on the outside (both elastic) and featuring an elastic Lycra strap. The ankle support is open at the front for easy fitting. Fastening is by means of Velcro straps, enabling it to be adjusted to suit the physical characteristics of each patient, and a figure-of-eight elastic strap for stabilisation.

Indications:

- Light sprains.
- Tendinitis.
- Recurrences.

Colour:  Black and grey.

Ref.: OP1192 RIGHT
Ref.: OP1193 LEFT
PEDIATRIC NIGHT-TIME HALLUX VALGUS CORRECTION ORTHOSIS

SIZES	AGE
1	2-6
2	6-12

Characteristics:

Made from breathable honeycomb fabric on the inside and terrycloth on the outside, it features a malleable aluminium abductor splint for adjusting the position of the big toe and two Velcro fasteners located on the back, as well as another one that can be adjusted to fit the big toe. It has an anterior pad that protects the first metatarsal head from chafing.

Indications:

- Postural correction of hallux valgus.
- Post-surgery.

Colour:  Green and grey.

Ref.: OP1172
LOWER LIMB REALIGNMENT ORTHOSIS TIB-ROT®

SIZES	PERIMETER A CM	PERIMETER B CM
1	48-55	28-35
2	52-61	31-40
3	56-65	37-46
4	62-71	41-50

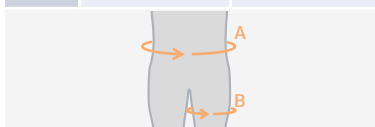

Characteristics:

Orliman's lower limb realignment orthosis is composed of a belt and two thigh supports linked by elastic straps that create traction from the inside of both thighs to the back of the belt with the aim of keeping the lower limbs in abduction and consequently achieving correct alignment. The belt and the thigh supports are made from velour and are fastened at the front by means of Velcro straps. They feature silicone dots on the inside to prevent displacement and rotation of the orthosis when being worn by the patient. The belt also has lumbar padding for comfort. The straps that link the belt and thigh supports are elastic and made from polyamide and elastane, and include a strip of elastic velour on the inside.

Indications:

- Conditions that cause malfunction in the alignment of the lower limbs as a consequence of neurological disorders.
- The aim of the orthosis is to provide a more functional gait pattern and greater autonomy for everyday activities.
- Gait disorders requiring positioning of the lower limbs in abduction in patients with cerebral palsy.
- Spina bifida.
- Disorders during embryonic development.
- Other rare disorders.
- Patients with hypotonic musculature.

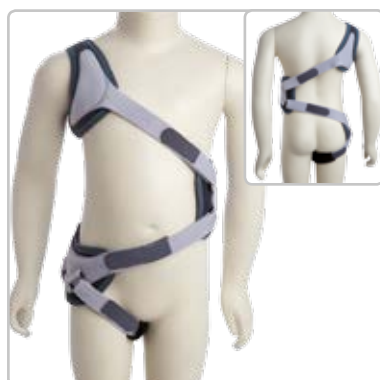
Colour:  Green and grey.

Ref.: OP1161
KALLABIS HARNESS

SIZES	ONE SIZE

Characteristics:

Orliman's Kallabis harness is manufactured in honeycomb fabric, terycloth and velour and features Velcro fasteners. It enables patients to stand up and begin walking. It consists of a shoulder band, a lower support situated at the level of the hip joint (both located on the concave side of the scoliosis curvature) and a contralateral support on the convex side (between the armpit and the bottom of the rib cage). These supports are joined by velour straps whose tension can be adjusted by means of simple Velcro fasteners.

Indications:

- Infantile scoliosis.

Colour:  Grey.

Ref.: OP1170
PAVLIK HARNESS

SIZES	AGE
1	newborns
2	9-24 months

Characteristics:

Orthosis for patients up to two years old featuring straps and a bib made from velour and booties made from thermoformed velour; the straps that pass over the shoulders are padded with neoprene to protect the baby's shoulders from chafing and the bib can be adjusted by means of Velcro fasteners. It features plastic buckles that enable the orthosis to be fitted and removed quickly and easily. The length of the straps can be adjusted to the characteristics of each patient.

Indications:

- Hip dysplasia.
- Dysplastic, dislocatable or unstable hips in the first months of life.
- Subluxations.
- As a complement to other orthopaedic or surgical treatments.

Colour:  Grey.



 **Thermo-med®**
Thermo-compression Orthesis

 **ORLIMAN® SPORT**

ELASTIC LINE

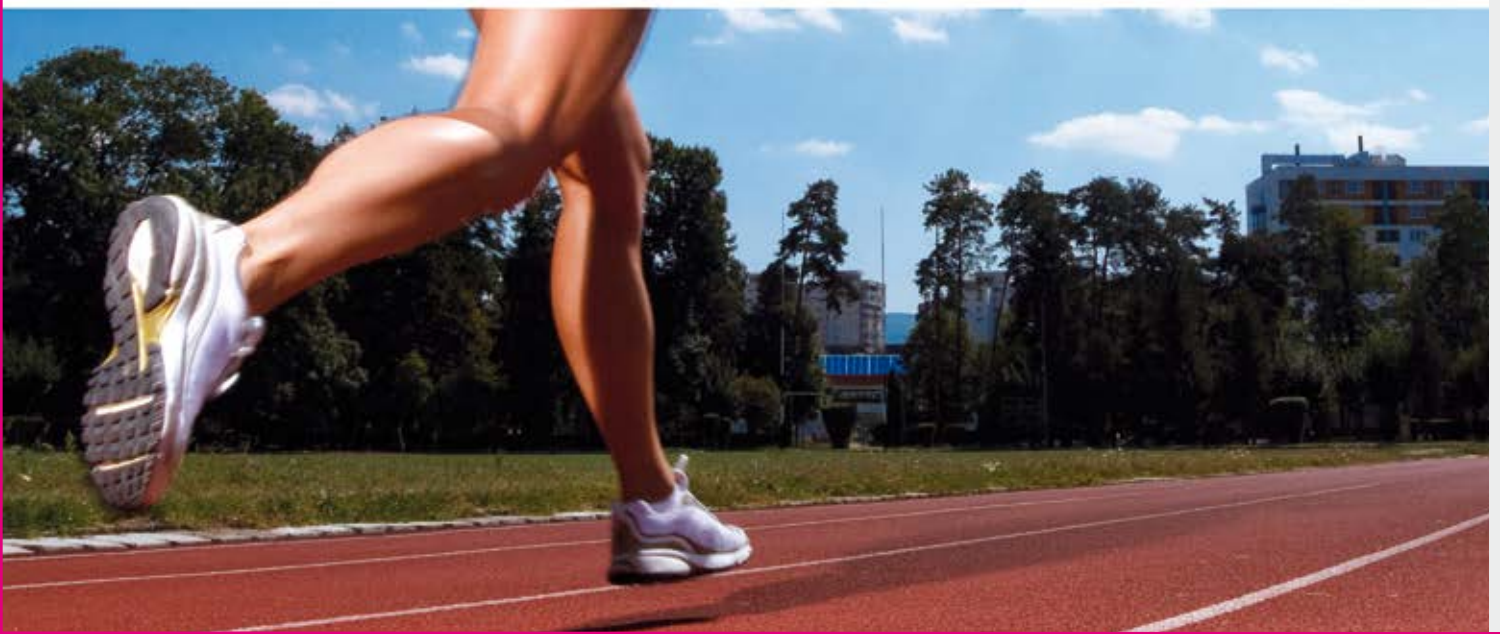



MAIN FEATURES

ORLIMAN® elaborates its thermal-grip garments with the best existing materials, fruit of the latest technological advances. All of its components have been tested to ensure unbeatable and a high quality of use.

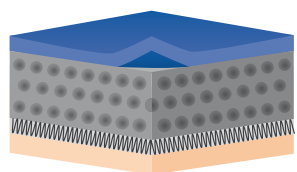

- Exterior Nylon layer
- Expanded rubber (Neoprene)
- Internal towel layer
- Skin

F Fastening **C** Compression **S** Stabilisation **I** Immobilization



Ref.: 4201

F .. C ... S .. I ..

NEOPRENE BACK SUPPORT

SIZES	PERIMETER CM	TROCHANTER	FRONT HEIGHT	BACK HEIGHT
XS/1	75-85			
S/2	85-95		16 cm	
M/3	95-110			28 cm
L/4	110-125			

Characteristics:

Back support in 4,5 mm neoprene. Front fastening of 10 cm Velcro and 16 cm velour for easy fit and greater security. Four plastic rear stays for support.

Indications:

- Provides support during sporting activities.
- Prophylaxis in jobs with mechanical overload in the lumbosacral region.
- Non-specific lumbar pathologies and prevention of back injuries.

Colours:

4201: Blue.
5201: Beige.



Ref.: 4202

F ... C ... S .. I ..

REINFORCED NEOPRENE BACK SUPPORT

SIZES	PERIMETER CM	TROCHANTER	FRONT HEIGHT	BACK HEIGHT
XS/1	75-85			
S/2	85-95		16 cm	
M/3	95-110			28 cm
L/4	110-125			

Characteristics:

Back support in 3 mm neoprene with nylon outer layer and soft polyester towelling interior. Front fastening of Velcro for easy fit and greater security. With two expanding adjustment bands to provide greater compression.

Indications:

- Lumbalgia.
- Rheumatic pains.
- Activities that require continued overexertion.

Colours:

4202: Blue.
5202: Beige.



Ref.: 4203

F ... C ... S .. I ..

CROSSED NEOPRENE BACK SUPPORT WITH CUSHION

SIZES	PERIMETER CM	TROCHANTER	FRONT HEIGHT	BACK HEIGHT
XS/1	75-85			
S/2	85-95		16 cm	
M/3	95-110			28 cm
L/4	110-125			

Characteristics:

Back support in 4,5 mm neoprene. Steel stays, rear crossed bands with Velcro front fastening and mouldable lumbar cushion.

Indications:

- Lumbago and lumbosciatica.
- Rheumatic pains.
- Lumboarthrosis.
- Atonic muscles and degenerative processes.
- Strong containment in activities that require continued exertion.
- Mouldable cushion allowing greater relief of the lumbar area.

Colours:

4203: Blue.
5203: Beige.



Ref.: 4204

F .. C .. S . I .

NEOPRENE ABDOMINAL BAND

SIZES	ONE SIZE
FRONT HEIGHT	
24 cm	
BACK HEIGHT	
24 cm	

Characteristics:

Band for light lumboabdominal support without reinforcements.

Indications:

- Lumbar symptoms.
- Slight lumbalgia.
- Individuals requiring gentle containment.

Colours: Blue.



Ref.: 4205

F ... C ... S ... I ...

NEOPRENE LUMBOSACRAL SUPPORT

SIZES	PERIMETER CM	TROCHANTER	FRONT HEIGHT	BACK HEIGHT
XS/1	75-85			
S/2	85-95		16 cm	
M/3	95-110			28 cm
L/4	110-125			

Characteristics:

Crossed bands in the posterior area and flexible plates.

Indications:

- Lumbar symptoms. Slight lumbalgia. Weak and atonic muscles.

Colours:

4205: Blue.
5205: Beige.

Thermo-med® ▶ Wrist support Thermo-compression Orthosis



Ref.: 4601 RIGHT

Ref.: 4602 LEFT

F ..

C ...

S .

I .

NEOPRENE SPLINT WRIST SUPPORT

SIZES	PERIMETER CM
XS/1	15-17
S/2	17-19
M/3	19-21
L/4	21-23



Characteristics:

3 mm neoprene wrist support with removable and moldable semi-spherical aluminium palm support and Velcro fasteners.

Indications:

- Instability by mild traumas.
- Tendonitis.
- Arthritis.

Colours:

4601-4602: ■ Blue.
5601-5602: ■ Beige.



Ref.: 4604

F ..

C ...

S .

I .

NEOPRENE THUMB WRIST SUPPORT

SIZES	PERIMETER CM
XS/1	15-17
S/2	17-19
M/3	19-21
L/4	21-23

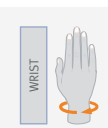

Characteristics:

3 mm neoprene wrist support, with Velcro fastening and moldable thumb splint.

Indications:

- Immobilisation and protection of the carpometacarpal and metacarpophalangeal joints.
- Slight wrist instabilities.
- Protection during sporting activities.

Colours:

4604: ■ Blue.
5604: ■ Beige.

Thermo-med® ▶ Shoulders Thermo-compression Orthosis



Ref.: 4801 RIGHT

Ref.: 4802 LEFT

F ..

C

S ..

I .

NEOPRENE SHOULDER SUPPORT

SIZES	PERIMETER CM A	PERIMETER CM B
S/2	32-40	20-25
M/3	40-48	25-30
L/4	48-56	30-35

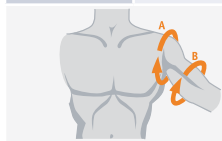

Characteristics:

Sleeve-shaped Neoprene shoulder support fastening under the contralateral arm.

Indications:

- Subluxations of the scapulo-humeral joint.
- Slight instabilities.
- Long-term painful processes.

Colours:

4801-4802: ■ Blue.
5801-5802: ■ Beige.



Ref.: 4803

F ..

C

S ..

I .

NEOPRENE BILATERAL SHOULDER SUPPORT

SIZES	PERIMETER CM A	PERIMETER CM B
S/2	32-40	20-25
M/3	40-48	25-30
L/4	48-56	30-35

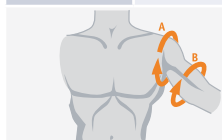

Characteristics:

Double neoprene shoulder support in waistcoat shape and with front Velcro fastening.

Indications:

- Subluxations of the scapulo-humeral joint.
- Slight instabilities.
- Long-term painful processes.
- Prevention in sports or activities where the joint is subject to overexertion.

Colours:

4803: ■ Blue.
5803: ■ Beige.



Ref.: 4300

F .. C ... S .. I .

NEOPRENE ELBOW SUPPORT

SIZES	PERIMETER CM	
XS/1	21-24	 Perimeter in cm around centre of elbow.
S/2	24-26	 Perimeter in cm around centre of elbow.
M/3	26-29	 HEIGHT 22 cm
L/4	29-32	 HEIGHT 22 cm
XL/5	32-35	 HEIGHT 22 cm

- Characteristics:**
3 mm neoprene elbow support with shape and trimming parts in the distal areas to avoid migration of the garment.
- Indications:**
• Prevention of sporting injuries.
- Colours:**
4300: Blue.
5300: Beige.



Ref.: 4301

F ... C ... S ... I ..

NEOPRENE EPICONDYLITIS ELBOW SUPPORT

SIZES	PERIMETER CM	
XS/1	21-24	 Perimeter in cm around centre of elbow.
S/2	24-26	 Perimeter in cm around centre of elbow.
M/3	26-29	 HEIGHT 23 cm
L/4	29-32	 HEIGHT 23 cm
XL/5	32-35	 HEIGHT 23 cm

- Characteristics:**
3 mm neoprene elbow support with Velcro strap that applies pressure at the level of the epicondyle and has two interchangeable cushions.
- Indications:**
• Epicondylitis (tennis elbow).
• Epitrochleitis. (golfer's elbow).
- Colours:**
4301: Blue.
5301: Beige.



Ref.: 4303

F .. C ... S .. I .

NEOPRENE PADDED ELBOW SUPPORT

SIZES	PERIMETER CM	
XS/1	21-24	 Perimeter in cm around centre of elbow.
S/2	24-26	 Perimeter in cm around centre of elbow.
M/3	26-29	 HEIGHT 22 cm
L/4	29-32	 HEIGHT 22 cm
XL/5	32-35	 HEIGHT 22 cm

- Characteristics:**
3 mm neoprene elbow support with reinforcement area in 3 mm. It has shape and trimming parts in the distal areas to prevent migration of the garment.
- Indications:**
• Recommended for sporting activities.
- Colours:**
4303: Blue.
5303: Beige.





Ref.: 4100

F .. C ... S . I ..

CLOSED NEOPRENE KNEE SUPPORT

SIZES	PERIMETER CM
XS/1	32-34
S/2	34-36
M/3	36-38
L/4	38-41
XL/5	41-44
XXL/6	44-49

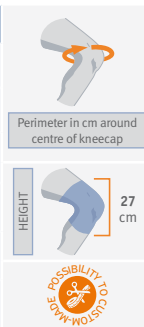

- Characteristics:**
4,5 mm neoprene knee support with closed kneecap.
- Indications:**
 - Minor contusions.
 - Arthrosis and arthritis.
 - Post-surgical treatments.
 - Rehabilitation.
 - Thermocompression, relief and protection.
- Colours:**
4100: Blue.
5100: Beige.



Ref.: 4101

F .. C ... S . I ..

NEOPRENE KNEE SUPPORT WITH OPEN KNEECAP

SIZES	PERIMETER CM
XS/1	32-34
S/2	34-36
M/3	36-38
L/4	38-41
XL/5	41-44
XXL/6	44-49



- Characteristics:**
4,5 mm neoprene knee support with open kneecap.
- Indications:**
 - Light contusions.
 - Arthrosis and arthritis.
 - Post-surgical treatments.
 - Rehabilitation.
 - Any knee pathology requiring the centring or relief of the kneecap.
 - Thermocompression, relief, protection and centring of the kneecap.
- Colours:**
4101: Blue.
5101: Beige.



Ref.: 4102

F .. C ... S .. I ..

NEOPRENE KNEE SUPPORT WITH FLEXIBLE LATERAL STABILISERS

SIZES	PERIMETER CM
XS/1	32-34
S/2	34-36
M/3	36-38
L/4	38-41
XL/5	41-44
XXL/6	44-49

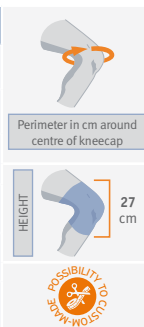

- Characteristics:**
4,5 mm neoprene knee support with open kneecap and spiral reinforcement stays for lateral stabilisation. With interchangeable kneecap padding.
- Indications:**
 - Minor contusions.
 - Arthrosis and arthritis.
 - Post-surgical treatment.
 - Rehabilitation.
 - Any knee pathology requiring the centring or relief of the kneecap.
 - Thermocompression, relief, protection, mediolateral stability and centring of the kneecap.
- Colours:**
4102: Blue.
5102: Beige.



Ref.: 4103

F .. C ... S .. I ..

NEOPRENE KNEE SUPPORT WITH FLEXIBLE LATERAL STABILISERS AND SECURING STRAPS

SIZES	PERIMETER CM
XS/1	32-34
S/2	34-36
M/3	36-38
L/4	38-41
XL/5	41-44
XXL/6	44-49



- Characteristics:**
4,5 mm neoprene knee support with flexible lateral stabilisers and upper and lower adjustment straps. Interchangeable patellar pad.
- Indications:**
 - Light contusions.
 - Arthrosis and arthritis.
 - Post-surgical treatments. Rehabilitation.
 - Thermocompression, relief, protection, optimum stabilisation of the articulation, permanent centring of the kneecap.
- Colours:**
4103: Blue.
5103: Beige.



Ref.: 4103-A

F .. C ... S .. I ..

NEOPRENE KNEE SUPPORT WITH THIGH AND CALF OPENINGS FLEXIBLE LATERAL STABILISERS AND ADJUSTMENT STRAPS

SIZES	PERIMETER CM
XS/1	32-34
S/2	34-36
M/3	36-38
L/4	38-41
XL/5	41-44
XXL/6	44-49



Characteristics:

4,5 mm neoprene knee support with flexible lateral stabilisers and upper and lower adjustment straps. Interchangeable patellar pad. Easy to fit and remove thanks to the thigh and calf openings.

Indications:

- Light contusions.
- Arthrosis and arthritis.
- Post-surgical treatments. Rehabilitation.
- Thermo-compression, relief, protection, stability, centring of the kneecap, adaptation to specific anatomies.

Colours:

4103-A: ■ Blue.
5103-A: ■ Beige.



Ref.: 4104

F .. C ... S .. I ..

NEOPRENE KNEE SUPPORT WITH POLYCENTRIC HINGE AND ADJUSTMENT STRAPS

SIZES	PERIMETER CM
XS/1	32-34
S/2	34-36
M/3	36-38
L/4	38-41
XL/5	41-44
XXL/6	44-49

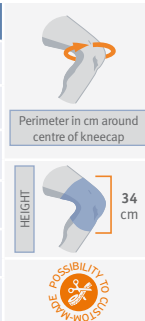

Characteristics:

4,5 mm neoprene knee support with metallic bands with polycentric articulation and upper and lower adjustment straps. Interchangeable patellar cushion. Calf opening.

Indications:

- Light contusions.
- Arthrosis and arthritis.
- Post-surgical treatments. Rehabilitation.
- Capsuloligamentous and medio-lateral instabilities.
- Thermo-compression, relief, protection, stability, permanent centring of the kneecap.

Colours:

4104: ■ Blue.
5104: ■ Beige.



Ref.: 4104-A

F .. C ... S .. I ..

NEOPRENE KNEE SUPPORT WITH POLYCENTRIC HINGE AND THIGH CALF OPENINGS

SIZES	PERIMETER CM
XS/1	32-34
S/2	34-36
M/3	36-38
L/4	38-41
XL/5	41-44
XXL/6	44-49



Characteristics:

4,5 mm neoprene knee support with metallic bands with polycentric articulation and upper and lower adjustment straps. Interchangeable patellar pad. Easy to fit and remove thanks to the thigh and calf openings.

Indications:

- Ligament instabilities.
- Arthrosis and arthritis.
- Post-surgical treatments. Rehabilitation.
- Thermo-compression, relief and protection, medio-lateral stability and centring of the kneecap.

Colours:

4104-A: ■ Blue.
5104-A: ■ Beige.



Ref.: 4105

F .. C ... S .. I ..

NEOPRENE KNEE SUPPORT FLEXIBLE LATERAL STABILISERS AND SILICONE KNEEPAD

SIZES	PERIMETER CM
XS/1	32-34
S/2	34-36
M/3	36-38
L/4	38-41
XL/5	41-44
XXL/6	44-49



Characteristics:

4,5 mm neoprene knee support with open kneecap and spiral reinforcement stays for lateral stabilisation. With silicone kneepad.

Indications:

- Femoropatellar injuries.
- Arthrosis and arthritis.
- Post-surgical treatment.
- Subluxations of the kneecap.
- Chondromalacia of the kneecap.
- Thermo-compression, relief, protection, micromassage of soft articulated areas and centring of the kneecap.

Colours:

4105: ■ Blue.
5105: ■ Beige.



Ref.: 4106

F • C • S • I •

NEOPRENE PADDED KNEE SUPPORT

SIZES	PERIMETER CM
XS/1	32-34
S/2	34-36
M/3	36-38
L/4	38-41
XL/5	41-44
XXL/6	44-49



Characteristics:

4,5 mm neoprene padded knee support.

Indications:

- In processes requiring heat and compression.
- Traumatism.
- Inflammations.
- Arthrosis.
- Post-surgical treatment.
- Rehabilitation.
- Bursitis.
- Acute and chronic knee complaints.
- Prevention in work involving knee-bending and kneecap loading.

Colours:

- 4106: ■ Blue.
- 5106: ■ Beige.



Ref.: 4109

F • C • S • I •

NEOPRENE KNEE SUPPORT CROSSED LIGAMENTS

SIZES	PERIMETER CM
XS/1	32-34
S/2	34-36
M/3	36-38
L/4	38-41
XL/5	41-44
XXL/6	44-49



Characteristics:

4,5 mm neoprene knee support with open kneecap, interchangeable patellar pad, adjustment strap and lateral stabilisers.Calf opening.

Indications:

- Kneecap distensions.
- Instability of crossed and lateral knee ligaments.

Colours:

- 4109: ■ Blue.
- 5109: ■ Beige.



Ref.: 4110

F • C • S • I •

NEOPRENE INFRAPATELLAR STRAP

SIZES	ONE SIZE
	ONE SIZE



Characteristics:

Infrapatellar compression pad with Velcro fastening.

Indications:

- Osgood-Schlatter disease.

Colour:

- Blue.



Ref.: 4111

F • C • S • I •

NEOPRENE KNEECAP SUPPORT

SIZES	PERIMETER CM
XS/1	32-34
S/2	34-36
M/3	36-38
L/4	38-41
XL/5	41-44
XXL/6	44-49



Characteristics:

4,5 mm neoprene kneecap support with infrapatellar Velcro fastening and patellar opening. Incorporates a compression tube to compress the kneecap ligament, before its insertion in the tuberosity of the tibia, this way minimising the mechanic strains.

Indications:

- Osgood-Schlatter disease.
- Chondromalacia of the kneecap.

Colours:

- 4111: ■ Blue.
- 5111: ■ Beige.



Ref.: 4112 SHORT | **Ref.: 4113 LONG**

F ... C ... S ... I

NEOPRENE KNEE SUPPORT FOR FLEXION-EXTENSION CONTROL

SIZES	PERIMETER CM
XS/1	32-34
S/2	34-36
M/3	36-38
L/4	38-41
XL/5	41-44
XXL/6	44-49

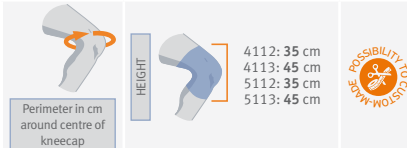

Characteristics:

4,5 mm neoprene knee support with polycentric articulation of 0-15- 30-60-90 degrees of flexion-extension. Velcro calf and thigh fastenings, popliteal openings (1 adjustment strap on thigh and 1 on calf in Ref. 4112), (2 adjustment straps on thigh and 2 on calf on ref. 4113). With interchangeable patellar cushion.

Indications:

- Post-operative and post-surgical treatment of the knee.
- Rehabilitation after injuries.
- To obtain a range of control of the mobility of the operated knee (crossed ligament surgery).

Colours:

4112/4113: ■ Blue.
5112/5113: ■ Beige.



Ref.: 4115

F ... C ... S ... I

NEOPRENE GENU-STAR KNEE SUPPORT FOR FLEXION-EXTENSION CONTROL

SIZES	PERIMETER CM
XS/1	32-34
S/2	34-36
M/3	36-38
L/4	38-41
XL/5	41-44
XXL/6	44-49



Characteristics:

4,5 mm neoprene knee support with monocentric articulation for graduations set at 0-30- 60-90 degrees of flexion-extension. Femoral opening. Double Velcro fastenings in proximal and distal parts.

Indications:

- Post-operative and post-surgical treatment of the knee.
- Chronic instabilities.
- Rehabilitation after injuries.

Colours:

4115: ■ Blue.
5115: ■ Beige.



Ref.: 4116

F .. C ... S .. I ..

NEOPRENE STABILISER KNEE SUPPORT WITH SILICONE KNEEPAD, LATERAL FLEXIBLE STABILISERS AND ADJUSTMENT STRAPS

SIZES	PERIMETER CM
XS/1	32-34
S/2	34-36
M/3	36-38
L/4	38-41
XL/5	41-44
XXL/6	44-49



Characteristics:

4,5 mm neoprene knee support with open kneecap and spiral reinforcement stays for lateral stabilisation. With silicone kneepad and straps with elastic portion for better adjustment. Rear thigh and calf opening with Velcro for better adaptation.

Indications:

- Functional treatment in distensions, instabilities and contusions.
- Arthrosis and arthritis.
- The upper and lower openings lighten excessive pressures.

Colours:

4116: ■ Blue.
5116: ■ Beige.





Ref.: 4400

F .. C .. S .. I ..

CLOSED NEOPRENE ANKLE SUPPORT

SIZES	PERIMETER CM	
XS/1	22-24	<p>Over malleolus</p>
S/2	24-26	
M/3	26-28	
L/4	28-31	
XL/5	31-34	

Characteristics:

3 mm neoprene ankle support with trimming parts in the upper part for better adjustment.

Indications:

- Slight sprains.
- Tendonitis.
- Post-operatives.
- Relapses.

Colours:

4400: Blue.
5400: Beige.



Ref.: 4401

F ... C ... S ... I ...

NEOPRENE CROSSOVER ELASTIC ANKLE SUPPORT

SIZES	PERIMETER CM	
XS/1	22-24	<p>Over malleolus</p>
S/2	24-26	
M/3	26-28	
L/4	28-31	
XL/5	31-34	

Characteristics:

3 mm neoprene ankle support with Velcro adjustment straps in the upper part. Elastic adjustment strap in Velcro and velour to control the pronation and supination of the ankle.

Indications:

- Slight sprains.
- Tendonitis.
- Post-operatives and relapses.

Colours:

4401: Blue.
5401: Beige.



Ref.: 4402

F .. C ... S .. I ..

OPEN NEOPRENE ANKLE SUPPORT

SIZES	PERIMETER CM	
XS/1	22-24	<p>Over malleolus</p>
S/2	24-26	
M/3	26-28	
L/4	28-31	
XL/5	31-34	

Characteristics:

3 mm neoprene ankle support with velcro adjusters in the upper part.

Indications:

- Slight sprains.
- Tendonitis.
- Post-operatives and relapses.

Colours:

4402: Blue.
5402: Beige.



Ref.: 4403

F .. C ... S .. I ..

NEOPRENE ANKLE SUPPORT WITH ZIP

SIZES	PERIMETER CM	
XS/1	22-24	<p>Over malleolus</p>
S/2	24-26	
M/3	26-28	
L/4	28-31	
XL/5	31-34	

Characteristics:

3 mm neoprene ankle support with lateral zip to facilitate adjustment and adaptation.

Indications:

- Slight sprains.
- Tendonitis.
- Post-operatives and relapses.
- When there is inflammation or oedema that impedes placement.

Colours:

4403: Blue.
5403: Beige.



Ref.: 4404

F .. C ... S ... I ...

ANKLE SUPPORT WITH THERMOPLASTIC PLATES

SIZES	PERIMETER CM	
XS/1	22-24	<p>Over malleolus</p>
S/2	24-26	
M/3	26-28	
L/4	28-31	
XL/5	31-34	

Characteristics:

3 mm neoprene ankle support with crossed band and removable internal and external plastic malleolar plates. The plates can be placed on the left side as well as on the right, therefore to avoid rubbing and discomfort during fitting the plates have been labelled as internal and external.

Indications:

- Ligamentous instability.
- Tendonitis.
- Post-operatives and relapses.

Colours:

4404: Blue.
5404: Beige.



Ref.: 4406

F ... C ... S ... I ...

ANKLE STABILISER IN NEOPRENE WITH DOUBLE MEDIOLATERAL SUPPORTS

SIZES	PERIMETER CM
XS/1	22-24
S/2	24-26
M/3	26-28
L/4	28-31
XL/5	31-34



Characteristics:

3 mm neoprene ankle support with elastic strapping and mediolateral support. Bilateral ankle support with zip fasteners, making it easier for people with swollen or weak ankles, as well as those suffering rheumatoid arthritis, etc.

Colour: ■ Blue.



Ref.: 4500

F ... C ... S ... I ...

NEOPRENE THIGH SUPPORT

SIZES	PERIMETER CM
XS/1	45-48
S/2	48-52
M/3	52-57
L/4	57-64



Characteristics:

3 mm neoprene thigh support. With elastic distal straps made in conical shape adapted to the different circumferences of the thigh.

Indications:

- Prevention of muscular tears, mainly in quadriceps and abductors.

Colours:

4500: ■ Blue.
5500: ■ Beige.



Ref.: 4700

F ... C ... S ... I ...

NEOPRENE TROUSERS

SIZES	PERIMETER CM
XS/1	75-85
S/2	85-95
M/3	95-105
L/4	105-115



Characteristics:

2 mm neoprene trousers ideal for sports. Front zip fastener for ease of adjustment.

Indications:

- Ideal for preventing sports injuries.
- Overload situations.
- Inguinal problems.

Colours:

4700: ■ Blue.
5700: ■ Beige.



Ref.: 4701

F ... C ... S ... I ...

HIGH NEOPRENE TROUSERS

SIZES	PERIMETER CM
XS/1	75-85
S/2	85-95
M/3	95-105
L/4	105-115



Characteristics:

2 mm neoprene trousers ideal for sports. With sufficient height to provide heat to the lumbar muscles and increase sweating in this area. Frontal zip fastener for ease of adjustment.

Indications:

- Ideal for preventing sports injuries especially in those with weakness in the lumbar muscles.
- Situations of overload.
- Inguinal problems.

Colours:

4701: ■ Blue.
5701: ■ Beige.





Ref.: 4702

F ... C ... S . I .

SHORT NEOPRENE TROUSERS

SIZES	PERIMETER CM	TROCHANTER
XS/1	75-85	
S/2	85-95	POSSIBILITY TO CUSTOM-MAKE
M/3	95-105	
L/4	105-115	

Characteristics:

2 mm neoprene trousers ideal for sports. Without fasteners, being a short model and in elastic material they adapt to any anatomy.

Indications:

- Ideal for preventing sports injuries.
- Relief situation.
- Inguinal problems.

Colour: ■ Blue.



Ref.: 4800

F ... C ... S . I .

NEOPRENE CALF SUPPORT

SIZES	PERIMETER CM	TROCHANTER
XS/1	27-29	
S/2	29-32	POSSIBILITY TO CUSTOM-MAKE
M/3	32-35	
L/4	35-39	

Characteristics:

3 mm neoprene calf support. With elastic distal straps, conical shape that is adapted to the different calf anatomies.

Indications:

- Indicated in muscular pathologies.
- For protection of the anterior spine of the tibia.

Colours:

4800: ■ Blue.
5800: ■ Beige.



Ref: 5501 RIGHT

Ref: 5502 LEFT

F .. C . S ... I .

NEOPRENE SUPPORT BELT FOR FEMURAL PROTHESIS

SIZES	PERIMETER CM A	PERIMETER CM B
S/2	85-100	40-50
M/3	85-110	48-58
L/4	105-125	56-66

Characteristics:

3 mm neoprene thigh support. With elastic distal straps made in conical shape adapted to the different circumferences of the thigh.

Indications:

- Prevention of muscular tears, mainly in quadriceps and abductors.

Colour: ■ Beige.





Exhibitor

Ref.: Exp-ONE-Cartón
Units: 14
Sizes: 48 x 50 x 30 cm



Ref.: 4119

F .. C ... S .. I .

NEOPRENE OPEN KNEE SUPPORT

SIZES	ONE SIZE
HEIGHT  27 cm	

Characteristics:

The stabilising one size kneecap support enables tension control by means of adjustable bands that favour a perfect adaptation to the kneecap, without bothering the popliteal area. Made from 2 mm astrakhan neoprene, with thermal properties that relieve pain and favour recovery and maintain the flexibility of the joints. It is light and comfortable for a daily use.

Indications:

- Light contusions.
- Arthrosis and arthritis.
- Post-surgical treatment.
- Rehabilitation.
- Any knee pathology in which centring or unloading of the kneecap is necessary.



Colour:  Blue.



Ref.: 4405

F .. C .. S . I .

NEOPRENE ANKLE SUPPORT

SIZES	ONE SIZE
	

Characteristics:

The stabilising one size ankle support enables tension control by means of adjustable bands that favour a perfect adaptation both in the instep as in the calcaneus. With a perforated sole surface, to facilitate transpiration. Made from 2 mm astrakhan neoprene, with thermal properties that relieve pain and favour recovery and maintain the flexibility of the joints. It is light and comfortable for a daily use.

Indications:

- Slight sprains.
- Tendonitis.
- Post-operatives.
- Relapses.

Colour:  Blue.



Ref.: 4200

F ... C ... S .. I ..

NEOPRENE BACK SUPPORT

SIZES	ONE SIZE
FRONT HEIGHT  17 cm	BACK HEIGHT  24 cm
	

Characteristics:

Made from two types of material, the front in astrakhan neoprene of 2 mm and the back in normal neoprene of 3 mm. Adjustment fastener of 28 cm, which enables the adaptation to different anatomies. Neoprene retains body heat facilitating blood circulation, meanwhile relieving pain and favour the recovery and maintaining flexibility of the joint. It is light and comfortable for daily use.

Indications:

- Provides support during sporting activities.
- Prophylaxis in jobs with mechanical overload in the lumbosacral region.
- Non-specific lumbar pathologies and prevention of back injuries.

Colour:  Blue.



Ref.: 4304

F • C • S • I •

NEOPRENE ELBOW SUPPORT

SIZES	ONE SIZE
<p>HEIGHT 22 cm</p>	<p>POSSIBILITY TO CUSTOM-MAKE</p>

Characteristics:

The one size elbow support allows for tension control by means of adjustable bands that favour a perfect adaptation to the elbow joint. The joint area is perforated to facilitate transpiration. Made from 2 mm astrakhan neoprene.

Indications:

- Prevention of sporting injuries.

Colour: ■ Blue.



Ref.: 4600

F • C • S • I •

NEOPRENE WRIST SUPPORT

SIZES	ONE SIZE
	<p>POSSIBILITY TO CUSTOM-MAKE</p>

Characteristics:

3 mm neoprene wrist support with interior elastic strap to facilitate the adaptation by the patients themselves.

Indications:

- Prevention of wrist injuries.

Colour: ■ Blue.



Ref.: 4302

F • C • S • I •

NEOPRENE EPICONDYLITIS ARMBAND

SIZES	ONE SIZE
	<p>POSSIBILITY TO CUSTOM-MAKE</p>

Characteristics:

3 mm neoprene band reinforced with Velcro strap and two adjustable cushions in plastazote.

Indications:

- Prevention of sporting and workrelated injuries.
- Epicondylitis (tennis elbow).
- Epitrocleitis. (golfer's elbow).

Colour: ■ Blue.



Ref.: 4603

F • C • S • I •

NEOPRENE WRIST SUPPORT BANDAGE

SIZES	ONE SIZE
	<p>POSSIBILITY TO CUSTOM-MAKE</p>

Characteristics:

2 mm neoprene wrist support bandage, special for bandaging, that allows use on both the right and left hand.

Indications:

- Slight instabilities.
- Prevention in sports.
- Work-related prevention when carrying out repetitive movements of the wrist.

Colour: ■ Blue.



Ref.: 4607

F • C • S • I •

NEOPRENE THUMB WRIST SUPPORT BANDAGE

SIZES	ONE SIZE
	<p>POSSIBILITY TO CUSTOM-MAKE</p>

Characteristics:

Same characteristics as 4603, but includes thumb tube in the thumb area, which provides a light containment and thermal support in the trapeziummetacarpal joint, with 2 mm neoprene.

Colour: ■ Blue.



Ref.: OS6261

ADJUSTABLE WRIST SUPPORT

SIZES	ONE SIZE
-------	----------

Characteristics:

Manufactured in a breathable stretch knit fabric that is very strong and soft for added comfort; its seamless construction means no uncomfortable rubbing. Includes an elastic strap for individualised adjustment to achieve selective tightness.

Indications:

- Wrist injury prevention, tendonitis and mild tenosynovitis.
- Support and protection for athletic and work activities.

Colour: ■ Grey.



Ref.: OS6260

ELASTIC WRIST SUPPORT

SIZES	PERIMETER CM	
S/1	15-18	
M/2	18-21	
L/3	21-24	

Characteristics:

Manufactured in a breathable stretch knit fabric that is very strong and soft for added comfort; its seamless construction means no uncomfortable rubbing. 3D anatomical adjustment. Includes an elastic strap for individualised adjustment to achieve selective tightness.

Indications:

- Tendonitis, osteoarthritis, mild contusions, minor injuries and instability, inflammatory processes.
- Support and protection for athletic and work activities.

Colour: ■ Grey.



Ref.: OS6230

ELASTIC ELBOW SUPPORT WITH GEL PADS

SIZES	PERIMETER CM	
S/1	22-26	
M/2	26-30	
L/3	30-34	

Characteristics:

Manufactured in a breathable stretch knit fabric that is very strong and soft for added comfort; its seamless construction means no uncomfortable rubbing. 3D anatomical adjustment. The product includes viscoelastic pads that redistribute the compression on the epicondyle and epitrochlea, and an elastic strap for individualised adjustment to achieve selective tightness.

Indications:

- Epicondylitis (tennis elbow), epitrochleitis (golfer's elbow), tendonitis, mild contusions, inflammatory processes, injuries and instability.
- Support and protection for athletic and work activities.

Colour: ■ Grey.



Ref.: OS6211

ELASTIC KNEE SUPPORT WITH LATERAL STABILISERS

SIZES	PERIMETER CM	
S/1	32-36	
M/2	36-41	
L/3	41-48	

Characteristics:

Manufactured in a breathable stretch knit fabric that is very strong and soft for added comfort; its seamless construction means no uncomfortable rubbing. 3D anatomical adjustment. Includes a ring-shaped viscoelastic pad and lateral stabilisers for improved medio-lateral control.

Indications:

- Osteoarthritis, arthrosis, minor knee injuries and instability, inflammatory processes.
- Support and protection for athletic and work activities.

Colour: ■ Grey.



Ref.: OS6801

ELASTIC THIGH SUPPORT



SIZES	PERIMETER CM
S/1	45-49
M/2	49-54
L/3	54-61



Characteristics:

Manufactured in a breathable stretch knit fabric that is very strong and soft for added comfort; its seamless construction means no uncomfortable rubbing.

Indications:

- Prevention of tears of the quadriceps and abductor muscles as well as of the ischiotibial and adductor muscles.
- Support and protection for athletic and work activities.

Colour: ■ Grey.



Ref.: OS6804

ELASTIC CALF SUPPORT



SIZES	PERIMETER CM
S/1	27-31
M/2	31-36
L/3	36-42



Characteristics:

Manufactured in a breathable stretch knit fabric that is very strong and soft for added comfort; its seamless construction means no uncomfortable rubbing.

Indications:

- Indicated for muscle disorders and tibial protection.
- Support and protection for athletic and work activities.

Colour: ■ Grey.



Ref.: OS6240

ELASTIC ANKLE SUPPORT WITH GEL PADS



SIZES	PERIMETER CM
S/1	17-20
M/2	20-23
L/3	23-26



Characteristics:

Manufactured in a breathable stretch knit fabric that is very strong and soft for added comfort; its seamless construction means no uncomfortable rubbing. 3D anatomical adjustment. Includes viscoelastic pads that redistribute bandage compression from the prominent ankle bones to the surrounding soft tissues.

Indications:

- Mild ankle instability, joint effusion and inflammation of traumatic origin as well as that caused by previous diseases, postoperative and post-injury irritation (after sprains), tendomyopathies.
- Support and protection for athletic and work activities.

Colour: ■ Grey.



Ref.: OS6241

ADJUSTABLE ANKLE SUPPORT

SIZES	PERIMETER CM
S/1	17-20
M/2	20-23
L/3	23-26



Characteristics:

Manufactured in a fine, lightweight elastic material that is very strong and soft for added comfort.

Indications:

- Mild injuries, sprains, dislocations.
- Support and protection for athletic and work activities.

Colour: ■ Grey.

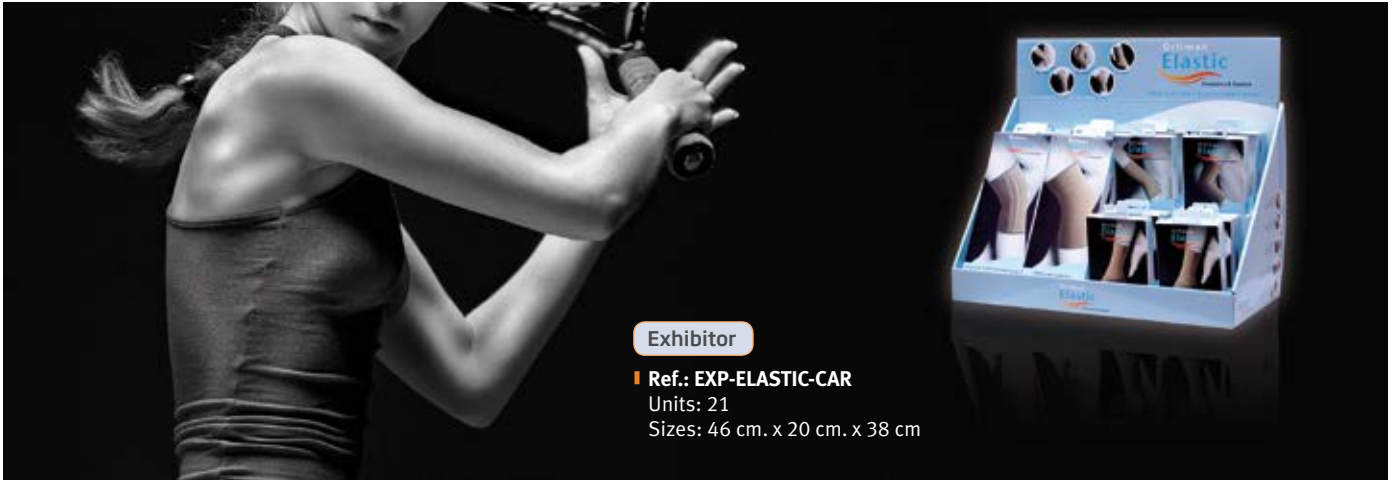

Exhibitor

Ref.: EXP-ELASTIC-CAR
Units: 21
Sizes: 46 cm. x 20 cm. x 38 cm



Ref: TN-261

F • C •• S • I •

ADJUSTABLE ELASTIC WRIST BAND

SIZES ONE SIZE



Characteristics:

Made of breathable elastic line highly resistant stretch fabric and soft, which gives the product greater comfort.

Indications:

• Prevention of wrist injuries, tendinitis, low grade tenosynovitis.

Colour: ■ Beige.



Ref: TN-262

F • C •• S • I •

WRAP-AROUND WRIST SUPPORT

SIZES ONE SIZE



Characteristics:

Made of breathable elastic line highly resistant stretch fabric and soft, which gives the product greater comfort.

Indications:

• Prevention of sporting and work injuries, trapeziometacarpal joint irritation associated with wrist injuries.

Colour: ■ Beige.



Ref: TN-260

F •• C •• S • I •

ELASTIC WRIST SUPPORT

SIZES	PERIMETER CM	LENGTH
S/1	15-18	17
M/2	18-21	
L/3	21-24	



Characteristics:

Made of breathable elastic line highly resistant stretch fabric and soft, which gives the product greater comfort.

Indications:

• Tendonitis, arthrosis and arthritis, support and protection for sports and work activities, slight contusions, minor trauma and instability.
• Inflammatory processes.

Colour: ■ Beige.



Ref: TN-230

F •• C •• S • I •

ELASTIC ELBOW SUPPORT

SIZES	PERIMETER CM	LENGTH
S/1	22-26	23
M/2	26-30	
L/3	30-34	



Characteristics:

Made of breathable elastic line highly resistant stretch fabric and soft, which gives the product greater comfort.

Indications:

• Lateral and medial epicondylitis, tendonitis, support and protection for sports and work activities, slight contusions, minor trauma and instability.
• Inflammatory processes.

Colour: ■ Beige.



Ref: TN-210

F .. C .. S . I .

ELASTIC KNEE SUPPORT

SIZES	PERIMETER CM	LENGTH
S/1	32-36	24
M/2	36-41	
L/3	41-48	



Characteristics:

Made of breathable elastic line highly resistant stretch fabric and soft, which gives the product greater comfort.

Indications:

- Arthritis and arthrosis, support and protection for sports and work activities, slight contusions, minor trauma and instability.
- Inflammatory processes.

Colour: ■ Beige.



Ref: TN-211

F .. C .. S .. I .

ELASTIC KNEE SUPPORT WITH BRACES

SIZES	PERIMETER CM	LENGTH
S/1	32-36	24
M/2	36-41	
L/3	41-48	



Characteristics:

Made of breathable elastic line highly resistant stretch fabric and soft, which gives the product greater comfort.

Indications:

- Arthritis and arthrosis brace, support and protection for sports and work activities, slight contusions, minor trauma and instability.
- Inflammatory processes.

Colour: ■ Beige.



Ref: TN-240

F . C .. S . I .

ELASTIC ANKLE SUPPORT

SIZES	PERIMETER CM	LENGTH
S/1	17-20	23
M/2	20-23	
L/3	23-26	



Characteristics:

Made of breathable elastic line highly resistant stretch fabric and soft, which gives the product greater comfort.

Indications:

- Slight contusions and sprains, tendonitis, support and protection for sports and work activities, minor trauma and instability.
- Inflammatory processes.

Colour: ■ Beige.



Ref: TN-241

F .. C .. S . I .

ADJUSTABLE ELASTIC ANKLE SUPPORT

SIZES	PERIMETER CM	LENGTH
S/1	17-20	23
M/2	20-23	
L/3	23-26	



Characteristics:

Made of breathable elastic line highly resistant stretch fabric and soft, which gives the product greater comfort.

Indications:

- Slight injuries and sprains.
- Luxations.
- As a precautions in sports.

Colour: ■ Beige.



SOFY-PLANT[®]



orliven[®]
TECHNICAL SOCKS

MAIN FEATURES



1 2 3

MAXIMUM ELASTICITY silicone insoles

The SOFY-PLANT silicone insoles unload the whole foot, especially the support areas of the metatarsals and the heel. Its two densities (one especially soft for the unloading areas) absorb shocks and impacts from the ground while walking, providing relief and comfort by avoiding pressure on the area of the heel and the metatarsals.

Especially indicated for tired, weak and delicate feet and in post-surgery situations. Also indicated for the practice of any sport that requires an extended effort.

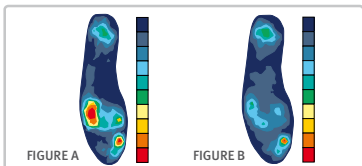

Comparing figures A and B a significant reduction can be seen in the maximum pressure in the area of the heel and the top of the 5th metatarsal, moving from pressure maximums of 600Kpa to maximums of about 250 Kpa. SOFY-PLANT insoles and heelpieces are made of a notably pleasant material to touch and are made of 100% silicone, which makes them perfectly tolerable and easily washed with cold water and without any type of soap.



Ref.: TL-601

SILICONE HEEL CUP

SIZES	FOOTWEAR SIZE
1	35-38
2	39-42
3	43-46



Units for packaging: 1 pair.

Characteristics:

Due to their visco-elastic properties, these silicone heel cups cushion the load points both during walking and in static position.

Indications:

- Relieve talgalgia.
- Bursitis.
- Tendonitis of the Achilles tendon.

Colour: Transparent.



Ref.: TL-611

SILICONE HEEL CUP WITH CENTRAL SPUR

SIZES	FOOTWEAR SIZE
1	35-38
2	39-42
3	43-46



Units for packaging: 1 pair.

Characteristics:

Due to their viscoelastic properties, these silicone heel supports cushion the load points both during walking and in static position. They have a circular area of softer consistency in the heel (blue area in).

Indications:

- Treatment of centralised calcaneus spur.
- Bursitis of the heel.
- Absorption of impacts.

Colour: Transparent.



Ref.: TL-612

SILICONE HEEL CUP WITH LATERAL SPUR

SIZES	FOOTWEAR SIZE
1	35-38
2	39-42
3	43-46



Units for packaging: 1 pair.

Characteristics:

Due to their viscoelastic properties, these silicone heel supports cushion the load points both during walking and in static position. They have an oval area of softer consistency in the heel (blue area).

Indications:

- Lateralised spur.
- Bursitis of the heel.

Colour: Transparent.



Ref.: TL-613

ANATOMICAL SILICONE HEEL CUP FOR CENTRAL SPUR

SIZES	FOOTWEAR SIZE
1	35-38
2	39-42
3	43-46



Units for packaging: 1 pair.

Characteristics:

Heel support made of silicone which, due to its viscoelastic properties, cushions the load points both during walking and in static position. It has an asymmetric area of softer consistency in the heel (blue zone). Base with anatomic form and greater width in the front part favouring the distribution of the loads between retroflex and half-flex, the control of the calcaneus and improves stability.

Indications:

- Treatment of calcaneus spur and bursitis of the heel.
- Tendonitis of the Achilles tendon.
- Plantar fasciitis and talgalgia.

Colour: Transparent.



Ref.: TL-617-10 (10 mm) | Ref.: TL-617-05 (5 mm)

FLAT SILICONE HEEL CUP WITH CENTRAL SPUR

SIZES	FOOTWEAR SIZE
1	35-38
2	39-42
3	43-46
4	47-50



Units for packaging: 1 pair.

Characteristics:

Due to their viscoelastic properties, these silicone heel supports cushion the load points both during walking and in static position. They have a circular area of softer consistency in the heel (blue area). Without lateral edges and with a height of 10 mm (TL-617-10) and 5 mm (TL-617-05).

Indications:

- Treatment of centralised calcaneus spur.
- Bursitis of the heel and absorption of impacts.
- In lower member dysmetrias of 1 cm (TL-617-10) and 0.5 cm (TL- 617-05).

Colour: Transparent.



Ref.: TL-619

SILICONE HEEL CUP FOR EXCESSIVE PRONATION OR SUPINATION

SIZES	FOOTWEAR SIZE
1	35-38
2	39-42
3	43-46



Units for packaging: 1 pair.

Characteristics:

Silicone heel cup for excessive pronation or supination. It corrects heel deviation to improve posture and prevent disorders caused by poor positioning when walking.

Indications:

- For patients with excessive pronation or supination of the heels.

Colour: Transparent.



Ref.: TL-618F

LINED SILICONE HEEL CUP

SIZES	FOOTWEAR SIZE
1	35-38
2	39-42
3	43-46



Units for packaging: 1 pair.

Characteristics:

Perfect housing for the heel due to its bowl shape and the hypoallergenic polyester fabric which improves comfort and breathability and impedes bacterial growth. Easy to wash. New attachment system that uses Velcro to stick to the footwear so it does not move. Ideal height which allows it to be adapted to any type of footwear. It is a long term product due to its greater silicone resistance. Made from 2 density silicone.

Indications:

- Provides swift relief for ligaments and muscles especially in excess load conditions.
- It is also suitable for bursitis and tendonitis of the Achilles Heel (impact absorption).

Colour: Transparent and grey lining.

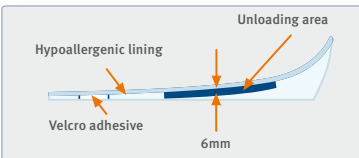

Ref.: PL-755

LONG SILICONE INSOLE WITHOUT RETROCAPITAL SUPPORT

SIZES	FOOTWEAR SIZE
0	35-36
1	37-38
2	39-40
3	41-42
4	43-44
5	45-46



Units for packaging: 1 pair.

Characteristics:

Insoles made with viscoelastic silicone with metatarsal and calcaneus supports in different density and with bridge.

Indications:

- Talalgia.
- Bursitis.
- Metatarsalgia.
- Calcaneus spur.
- Plantar fasciitis.
- Diabetic foot.
- Painful, tired or post-surgical feet. In sporting practice.

Colour: Transparent.



Ref.: PL-755F

LINED LONG SILICONE INSOLE WITHOUT RETROCAPITAL SUPPORT

SIZES	FOOTWEAR SIZE
0	35-36
1	37-38
2	39-40
3	41-42
4	43-44
5	45-46



Units for packaging: 1 pair.

Characteristics:

Insoles made with viscoelastic silicone with metatarsal and calcaneus supports in different density and bridge. Lined with hypoallergenic fabric in polyester that prevents bacterial growth and is easily washable.

Indications:

- Talalgia and bursitis.
- Metatarsalgia.
- Calcaneus spur.
- Plantar fasciitis.
- Diabetic foot.
- Painful, tired or post-surgical feet. In sporting practice.

Colour: Transparent and grey lining.



Ref.: PL-750

SILICONE INSOLE

SIZES	FOOTWEAR SIZE
0	35-36
1	37-38
2	39-40
3	41-42
4	43-44
5	45-46



Units for packaging: 1 pair.

Characteristics:

Insoles made with viscoelastic silicone with metatarsal and calcaneus supports in different density and with retrocapital support and bridge.

Indications:

- Talalgia and bursitis.
- Metatarsalgia and calcaneus spur.
- Plantar fasciitis and diabetic foot.
- Painful, tired or post-surgical feet. In sports.

Colour: Transparent.



Ref.: PL-750F

LINED SILICONE INSOLE

SIZES	FOOTWEAR SIZE
0	35-36
1	37-38
2	39-40
3	41-42
4	43-44
5	45-46



Units for packaging: 1 pair.

Characteristics:

Insoles made with viscoelastic silicone with metatarsal and calcaneus supports in different density and with retrocapital support and bridge. Lined with hypoallergenic fabric in polyester that prevents bacterial growth and is easily washable.

Indications:

- Talalgia and bursitis.
- Metatarsalgia and calcaneus spur.
- Plantar fasciitis and diabetic foot.
- Painful, tired or post-surgical feet. In sporting practice.

Colour: Transparent and grey lining.



Ref.: PL-760

3/4 SILICONE INSOLE

SIZES	FOOTWEAR SIZE
1	37-38
2	39-40
3	41-42
4	43-44



Units for packaging: 1 pair.

Characteristics:

Insoles made with viscoelastic silicone with metatarsal and calcaneus supports in different density and with bridge. The point of the foot is free.

Indications:

- Talalgia and bursitis.
- Metatarsalgia and calcaneus spur.
- Plantar fasciitis and diabetic foot.
- Painful, tired or post-surgical feet. In sporting practice.

Colour: Transparent.



Ref.: PL-760F

3/4 LINED SILICONE INSOLE

SIZES	FOOTWEAR SIZE
1	37-38
2	39-40
3	41-42
4	43-44



Units for packaging: 1 pair.

Characteristics:

Insoles made with viscoelastic silicone with metatarsal and calcaneus supports in different density and with bridge. Lined with hypoallergenic fabric in polyester that prevents bacterial growth and is easily washable.

Indications:

- Talalgia and bursitis.
- Metatarsalgia and calcaneus spur.
- Plantar fasciitis and diabetic foot.
- Painful, tired or post-surgical feet. In sporting practice.

Colour: Transparent and grey lining.



Ref.: PL-701F

LINED EXTRA-FINE INSOLE

SIZES	FOOTWEAR SIZE
0	35-36
1	37-38
2	39-40
3	41-42
4	43-44
5	45-46



Units for packaging: 1 pair.

Characteristics:

Insoles made with flexible extra-fine viscoelastic silicone, which allows great adaptation to the majority of footwear due to thinness, with metatarsal and calcaneus supports in different density and with retrocapital support and bridge. Lined with hypoallergenic fabric in polyester that prevents bacterial growth and is easily washable.

Indications:

- Talalgia and bursitis.
- Metatarsalgia and calcaneus spur.
- Plantar fasciitis and diabetic foot.
- Painful, tired or post-surgical feet. In sporting practice.

Colour: Transparent and grey lining.

Exhibitor

Ref.: Exp-FINE-Cartón
Units: 10
Sizes: 34 x 25 cm





Ref.: PL-702

INSOLE WITH METATARSAL ARCH

SIZES	FOOTWEAR SIZE
1	34-36
2	37-39
3	40-42



Units for packaging: 1 pair.

Characteristics:

An insole made from superfine flexible viscoelastic silicone, which can adapt to most footwear due to its reduced thickness, and featuring a metatarsal arch that helps to align the metatarsal heads, providing pain relief to the forefoot and preventing the formation of calluses in people who spend considerable time standing or walking. The insole can be cut to fit the footwear.

Indications:

- Metatarsalgia and forefoot pain.

Colour: Transparent.



Ref.: PL-700F

EXTRA-THIN LINED SILICONE INSOLES WITH METATARSAL PAD FOR LADIES

SIZES	FOOTWEAR SIZE
1	34-36
2	37-39
3	40-42

Units for packaging: 1 pair.

Characteristics:

Flexible extra-thin silicone insoles, with metatarsal pad which adapt perfectly to ladies shoes (high- heels or flats), due to their minimum thickness, ideal for all-day use. Lined with hypoallergenic polyester fabric that prevents bacterial growth, easy to clean. At the heel they incorporate an anti-slip system, preventing them from sliding out of place.

Indications:

- At the front of the foot they include a pad that provides a continuous damping effect in the metatarsal area, making them extremely comfortable.
- They relieve pain from the sole of the foot, preventing the formation of hard patches, they are shock-absorbing and reduce callosities.
- Pre-cut insoles.

Colour: Transparent and grey lining.

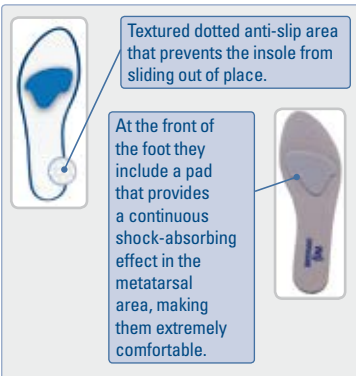

Exhibitor

Ref.: Exp-FINE-Cartón

Units: 14
Sizes: 34 x 25 cm



Ref.: PS-17

EXTRA-FINE SILICONE FOREFOOT CUSHION

SIZES	ONE SIZE

Units for packaging: 1 pair.

Characteristics:

The forefoot cushions are made with flexible extra-fine silicone, which allows perfect adaptation to the shoe, throughout the medial area of the foot. Its design incorporates raised circles on the external side.

Indications:

- Provides pain relief of the metatarsal and forefoot area, preventing formation of calluses and hardness.

Colour: Transparent.

MAIN FEATURES



Polymer gel: This is the name of a special mixture of polymers which are not toxic, to which a medicinal mineral oil has been incorporated.

► **POLYMER GEL TECHNOLOGY**

Thanks to the medicinal mineral oil which it contains, it hydrates, softens, protects and absorbs the affected area. Orliman Gels are transparent, not toxic, hypoallergenic, dermatologically tested and do not favor the growth of bacteria.

► **NUTRITIOUS ENVIRONMENT**

The specific gels based on the latest advances of Dermal Application Systems Technology provide a nutritious environment which favours healing and healthy skin.

► **WASHABLE AND REUSABLE**

All Orliman products are washable and reusable yet however they retain all their advantages. In fact, adequate cleaning and care contribute to a long life of the product.

► **CUSHIONS AND PROTECTORS**

Given the viscoelastic properties similar to those of fluids, our gels “flow” providing relief in situations of impact, sudden force, pressure, shock or vibration.

NEW DISPLAY PODOLOGY

Exhibitor

Ref.: EXP-SG
Units: 60
Sizes: 50x32 cm



Ref.: GL-100

TOE SPREADERS

SIZES	UNITS
S	2
M	
L	



► **Characteristics:**

Toe spreader made with non-toxic, hypoallergenic, dermatologically-tested, viscoelastic polymer gel that does not favour bacterial growth.

► **Indications:**

- Helps to preserve the alignment of the metatarsal phalangeal joint (ideal for the deformity of the bunion and deviation of the toe in post-operative care).
- Reduces friction, abrasion and irritation between adjacent or superimposed toes.

► **Colour:** Transparent.



Ref.: GL-123

TOE SPREADER WITH TOE LOOP

SIZES	UNITS
M	2
L	



► **Characteristics:**

The toe separator with ring for the big toe separates the toes to help maintain correct alignment, prevent chafing and relieve pressure on the big toe joint and painful bunions. Anatomically moulded for comfortable insertion between the toes. The flexible ring on the big toe holds the toe separator in place. The gel slowly releases medical-grade mineral oil and vitamins to protect the skin.

► **Indications:**

- Aligns deviating toes.
- Relieves pressure on the metacarpophalangeal joint.
- Separates and protects the toes.
- Washable and reusable.
- Patented design.

► **Colour:** Transparent.



Ref.: GL-101

TOE SEPARATORS

SIZES	UNITS
S	2
M	
L	
XL	



► **Characteristics:**

Half-moon separator made with nontoxic, hypoallergenic, dermatologically-tested, viscoelastic polymer gel that does not favour bacterial growth.

► **Indications:**

- Helps to protect against interdigit friction, abrasion and irritation caused by painful formations, such as spots, verrucas or ungual problems.
- Maintains alignment during healing for prolonged and post-operative use.

► **Colour:** Transparent.





Ref.: GL-102

PURE GEL BUNION SHIELD



SIZES	UNITS	POLYMER GEL
S	2	
L		

Characteristics:

Protector shaped around the bunion made with non-toxic, hypoallergenic, dermatologically tested, viscoelastic polymer gel that does not favour bacterial growth.

Indications:

- The bunion protector cushions and protects the bony protuberance.
- Absorbs pressure and friction.

Colour: Transparent.



Ref.: GL-124

BUNION TOE SPREADER



SIZES	UNITS	POLYMER GEL
ONE SIZE	1	

Characteristics:

The bunion toe spreader relieves pain caused by bunions and properly aligns the big toe. It absorbs stress placed on the metacarpophalangeal joint. Its patented design provides protection between big toe and shoe. The product slides easily over the big toe.

Indications:

- Reduces pressure and friction.
- Relieves bunion pain.
- Helps big toe realignment.
- Fits both feet.
- Patented design.

Colour: Transparent.



Ref.: GL-122

PURE GEL SIMPLE BUNION SHIELD



SIZES	UNITS	POLYMER GEL
ONE SIZE	2	

Colour: Transparent.



Ref.: GL-121

BUNION RELIEF SLEEVE



SIZES	UNITS	GEL INSIDE
S	1	
L		

Characteristics:

Absorbs shock and shear forces. The 3mm thin gel pad fits easily into shoes and other footwear. Soft, mineral oil gel softens and comforts painful and sensitive bunions (hallux valgus). The 3mm gel pad is in direct contact with the skin, moisturising and softening the skin. The comfort fabric secures comfortably over the big toe and around the foot, preventing sliding.

Colour: Beige.



Ref.: GL-103

PROTECTIVE BUNION SHIELD IN GEL WITH FABRIC

SIZES	UNITS	GEL INSIDE	PRE-CUT TEXTILE
S	1		
L			

Characteristics:

Protector that covers the area of the bunion, being placed on the toe. Made in viscoelastic polymer gel covered in elastic surgical fabric and with straps secured to the forefoot.

Indications:

- Cushions and protects the bony protuberance.
- Absorbs pressure and friction.

Colour: Beige.



Ref.: GL-104

DIGITAL PADS

SIZES	UNITS	
S	2	
M		
L		

Characteristics:

Ring-shaped cut tubes and with non-toxic, hypoallergenic, dermatologically tested viscoelastic polymer gel, which does not favour bacterial growth.

Indications:



- Relieves the pressure and friction of the affected toe.
- Contributes to reducing scar tissue.
- For ampoules, hammer toes, corns and toe traumas.

Colour: ■ Beige.



Ref.: GL-105

DIGITAL CAPS LINED

SIZES	UNITS		
S	1		
M			
L			

Characteristics:

Protector that covers the area of the bunion, being placed on the toe. Made in viscoelastic polymer gel covered in elastic surgical fabric and with straps secured to the forefoot.

Indications:

- Cushions and protects the bony protuberance.
- Absorbs pressure and friction.



Colour: ■ Beige.



Ref.: GL-117

PURE GEL DIGITAL CAP



SIZES	UNITS		
S	1		
M			
L			

Characteristics:

Tubular, toe-shaped, with non-toxic, hypoallergenic, dermatologically tested, viscoelastic polymer gel, which does not favour bacterial growth.

Indications:

- Helps relieve pressure and friction on the toes.
- Hammer toes, superimposed or infraposed toes.
- Keratotic injury or partially amputated toes.
- Skin or ungual problems due to dryness.

Colour: □ Transparent.



Ref.: GL-106

LINED GEL TUBING

SIZES	UNITS	LENGTH			
XS	1	15			
S					
M					
L					

Characteristics:

15 cm tubes and with non-toxic, hypoallergenic, dermatologically tested, viscoelastic polymer gel that does not favour bacterial growth. They can be cut according to length.

Indications:



- Helps relieve pressure and friction.
- Protection and hydration of toes.
- It helps reduce scar tissue.

Colour: ■ Beige.



Ref.: GL-107

CORN PADS

SIZES	UNITS	LENGTH			
S	1	10			
M					
L					

Characteristics:

10 cm tubes and with one side of non-toxic, hypoallergenic, dermatologically tested, viscoelastic polymer gel, which does not favour bacterial growth. They can be cut according to length.

Indications:

- Helps relieve pressure and friction.
- Protection and hydration of toes.
- It helps reduce scar tissue.

Colour: ■ Beige.



Ref.: GL-116

PURE GEL TUBING



SIZES	UNITS	LENGTH
S	1	15
M		
L		

- Characteristics:**
15cm tube of non-toxic, hypoallergenic, dermatologically-tested, viscoelastic polymer gel, which does not favour bacterial growth.
- Indications:**
 - Helps relieve pressure and friction.
 - Protection and hydration of toes.
 - Helps to reduce scar tissue.
- Colour:** Transparent.



Ref.: GL-118

GEL FULLY COATED DIGITAL MESH TUBE



SIZES	UNITS	LENGTH
S	1	15
L		

- Characteristics:**
The fabric is fully lined with vitamin enriched gel. Helps relieve pain from corns, calluses, nail problems, dry cuticles and abrasions. The flexible mesh fabric stretches easily for ease of application. The gel will not flatten out, unlike foam products. The gel tubes can easily be cut to size. Washable and reusable.
- Colour:** Beige.



Ref.: GL-115D RIGHT

Ref.: GL-115I LEFT

PURE GEL TOE CREST



SIZES	UNITS
S	1
M	
L	

FOOT	
R	L

- Characteristics:**
Small pads of non-toxic, viscoelastic polymer gel with ring secured to 2nd toe and with protuberance that raises the head of the first metatarsal.
- Indications:**
 - They provide relief for people with claw or hammer toes.
 - They offer maximum comfort and reduce pressure on the toes and metatarsal heads.
- Colour:** Transparent.



Ref.: GL-200

METATARSAL CUSHION LINED



SIZES	UNITS
S	1Pair
L	

- Characteristics:**
Pad in non-toxic, viscoelastic polymer gel, with ring secured to 2nd toe, covered in elastic surgical fabric.
- Indications:**
 - Protects the metatarsal area of the foot against friction and abrasion.
 - Indicated in metatarsalgia.
 - Helps to relieve the burning sensation and pain under the metatarsal heads.
 - Relieves the rubbing of corns, small neuromas, and tarsal adipose cushions.
 - It can be used as complement of soft cushion for metatarsalgia.
- Colour:** Beige.



Ref.: GL-201

PURE GEL METATARSAL CUSHION



SIZES	UNITS
S	1Pair
L	

- Characteristics:**
Pad with ring secured to 2nd toe, in non-toxic, viscoelastic polymer gel.
- Indications:**
 - Protects the metatarsal area of the foot against friction and abrasion.
 - Indicated in metatarsalgia which require an important unload.
 - Helps to relieve the burning sensation and pain under the metatarsal heads.
 - Relieves the rubbing of corns, small neuromas, and tarsal adipose cushions.
 - It can be used as complement of soft cushion for metatarsalgia.
- Colour:** Transparent.



Ref.: GL-206

METATARSAL ELASTIC BAND WITH ELEVATION

SIZES	SHOE SIZE	PERIMETER CM	UNITS
S	35-37	16-19	2
M	38-40	19-22	
L	41-43	22-26	

Characteristics:

Manufactured in stretch fabric, it provides support for the 2nd, 3rd and 4th metatarsals in the plantar area.

Indications:

Metatarsalgia, collapsed anterior arch of the foot (metatarsus latus).

Colour: ■ Beige.



Ref.: GL-207

ELASTIC BAND

SIZES	SHOE SIZE	PERIMETER CM	UNITS
S	35-37	16-19	2
M	38-40	19-22	
L	41-43	22-26	

Characteristics:

Manufactured in stretch fabric.

Indications:

Metatarsalgia, collapsed anterior arch of the foot (metatarsus latus).

Colour: ■ Beige.



Ref.: GL-208

DRESS BUNION RELIEF SLEEVE WITH GEL METATARSAL PAD

SIZES	UNITS	GEL INSIDE
S	1Pair	
L		

Characteristics:

The sleeve is made from a fine stretch fabric and contains a polymer gel pad that cushions the metatarsal and bunion area. Discreet and non-slip. Can fit either foot.

Indications:

- Reduces pressure and friction.
- Eases bunion pain.
- Absorbs shock.
- Prevents the formation of corns and reduces calluses.
- Relieves pain in the metatarsal area.

Colour: ■ Beige.



Ref.: GL-202D RIGHT

Ref.: GL-202I LEFT

METATARSAL ELASTIC BAND WITH GEL CUSHION

SIZES	UNITS	GEL INSIDE
S	1	
L		

Ref.: FR-GL-202 D/I Metatarsal elastic band with cushion 2cm more longer than Ref.: GL-202 D/I

Characteristics:

Tubular elastic band to be placed on the forefoot. With separation for the first toe and with plantar cushion in non-toxic, viscoelastic polymer gel.

Indications:

- Designed to cushion the plantar area and the metatarsal head.
- Relieves plantar pain.
- Shock absorber. Reduces calluses.

Colour: ■ Beige.



Ref.: GL-203

GEL FOOT COVER

SIZES	UNITS	GEL INSIDE
S	1Pair	
M		
L		

Characteristics:

Forefoot protector in non-toxic, viscoelastic polymer gel coated with elastic surgical fabric.

Indications:

- Helps to retain the body temperature in the toes.
- Comforts and relieves symptoms in individuals suffering from arthritis or cold toes due to poor circulation.

Colour: ■ Beige.





Ref.: GL-300

COMPLETE FOOT PROTECTOR IN GEL PINKY WITH FABRIC



SIZES	UNITS
S 36-38	1Pair
M 39-41	
L 42-44	



Characteristics:

Non-toxic, viscoelastic polymer gel sock covered with elastic surgical fabric.

Indications:

- Ideal for tired feet.
- Ideal for diabetic feet.
- Helps to retain body temperature in the feet.
- Comforts or alleviates symptoms in those suffering from arthritis or cold toes due to poor circulation.

Colour: ■ Beige.



Ref.: GL-204

Conforgel

MINI-PLANTAR BANDS WITH GEL



SIZES	UNITS
S <41	1Pair
L ≥41	



Characteristics:

Protect and relieve the pain in the metatarsal area, preventing the formation of hardness of the skin, shock absorber and reduces calluses.

Indications:

- The Mini plantars Conforgel bands, are manufactured with a fine elastic material and in the interior part they have a polymer gel cushion that provides a rapid relief to the metatarsal area.
- The minibands don't move.
- They are discreet and of sparse thickness, so you can use them in all kind of shoe.

Colour: ■ Beige.

Exhibitor

Ref.: Exp-G204-Cartón
Units: 10
Sizes: 20 x 30 x 18 cm



Ref.: GL-205

TOE STRAIGHTENER DOUBLE TOE

SIZES	UNITS
ONE SIZE	1

Characteristics:

The toe splint is the ideal solution to relieve pain caused by axial deviation, fractures or hammer toe. The splint helps to align the toes by means of adjustable rings while the soft double-layered anti-slip pad provides comfort for the metatarsal area of the foot.

Indications:

- Separates and aligns deformed, fractured and/or hammer toes.

Colour: ■ Beige.



Ref.: GL-410 (3-4 mm)

COVERED GEL SHEETS (3-4 MM)



MEASUREMENTS	UNITS
10x10	1
10x20	
12x30	
20x20	
30x40	
40x50	



Characteristics:

Polymer gel plates, 3-4 mm thick, nontoxic, viscoelastic, lined on one side with polyamide perforated elastic fabric.

Indications:

- Protect the skin from ulceration.
- Prevention of eschars.
- Burns.
- Ideal for unloading on soles and other Orthosis.

Colour: □ White.



Ref.: GL-420 (2-3 mm)

DOUBLE COVERED GEL SHEETS (2-3 MM)



MEASUREMENTS	UNITS
10x10	1
10x20	
12x30	
20x20	
30x40	



Characteristics:

Polymer gel plates, 2-3 mm thick, nontoxic viscoelastic, lined on one side with perforated polyamide elastic fabric and on the other with solid polyester elastic fabric.

Indications:

- Protects the skin from ulceration.
- Prevention of eschars.
- Burns.
- Ideal for unloading on soles and other orthoses.

Colour: Grey.



Ref.: PS-18

INVISIBLE FOREFOOT GEL MINIPADS.(SOFY-PLANT MINI)

SIZES	UNITS
ONE SIZE	1 Pair

Characteristics:

Maximum relaxation and total discretion; forget foot sole pain all day.

Indications:

- SOFY-PLANT MINI Invisible Forefoot Gel Minipads are designed to afford comfort and relief in the anterior region of the sole of the foot.
- They prevent the formation of corns and hardened areas, and offer anti-slipping characteristics and comfort.

Colour: Transparent.



SELF ADHESIVE



Ref.: PS-19

INVISIBLE FOREFOOT RELIEF PAD/BALL OF FOOT GEL CUSHION

SIZES	UNITS
ONE SIZE	1 Pair

Characteristics:

Relief of burning foot pain. Designed to absorb shock and pressure. Recommended for high heel shoes, sandals and boots. Provide all-day cushioning. Ultra slim to fit comfortably into shoes, sandals and boots. Durable. Transparent to match any shoe. Self adhesive. Non slip. Washable and re-usable. The gel pads will not compress like foams and felt products.

Colour: Transparent.



SELF ADHESIVE



Ref.: PS-20

SANDAL SPREADER WITH TEARDROP

SIZES	UNITS
ONE SIZE	1 Pair

Characteristics:

Helps to reduce friction and irritation between the toes, ensuring maximum comfort. The pad provides comfort for the middle metatarsals. Absorbs shock and pressure. Slim design for maximum comfort. Self adhesive for easy fit. Stay in place. Transparent. Washable and reuseable. One size.

Colour: Transparent.



Exhibitor

Ref.: Exp-SF-Carton
Units: 10
Sizes: 30 x 20 x 20cm



SELF ADHESIVE



Ref.: PS-21

FLEXIBLE SELF ADHESIVE HEEL GRIPS

SIZES	UNITS
ONE SIZE	1 Pair

Characteristics:

Washable, durable and hypoallergenic. The gel will not bottom out like foams. Ultra slim for easy fit. Self adhesive for easy fit. Transparent. Suitable for boots, shoes, and sandals. One size.

Colour: Transparent.

SELF ADHESIVE



Ref.: PS-22

3/4 LENGTH ADHESIVE GEL INSOLES WITH PRESSURE-RELIEF AREAS ON HEEL & FOREFOOT

SIZES	UNITS
ONE SIZE	1 Pair

Characteristics:

3/4-length adhesive insoles with antislip invisible gel that absorb pressure and provide comfort for the feet when wear your favourite shoes (high heels or flats) all day long, whether you are at work or during your leisure time. The ultra-thin insoles adapt easily inside the shoes preventing the burning feeling on the feet. The strategically located pressure relief areas provide additional cushioning under the heel and the forefoot. They absorb impacts and pressure. The adhesive prevents the insole from slipping and moving. Transparent. Washable and reusable. One size.

Colour: Transparent.

SELF ADHESIVE



Ref.: PS-23

ADHESIVE GEL HEEL CUSHIONS

SIZES	UNITS
ONE SIZE	1 Pair

Characteristics:

Ultra-thin anti-slip transparent gel pads that easily adapt to the back part of the inside of your shoes to prevent that burning feeling under the heels, the pressure-relief area absorbs impacts and pressure. The adhesive prevents them slipping and moving.

Colour: Transparent.



Ref.: HV-30 RIGHT | Ref.: HV-31 LEFT

NIGHTTIME HALLUX-VALGUS CORRECTOR

SIZES	ONE SIZE	
-------	----------	--

Characteristics:

Made in internal cotton bouclé in contact with the Beige. Comprises an abductor splint of moldable aluminium to regulate the position of the big toe. It covers the entire foot, and the perimeter can be regulated.

Indications:

- Correction of the Hallux-Valgus posture.
- Post-surgical.

Colour: Beige.



Ref.: HV-32

DAYTIME HALLUX-VALGUS CORRECTOR

SIZES	FOOTWEAR SIZE
1	35-38
2	39-44

Characteristics:

Comprises an elastic band around the instep and a cap for the big toe that is extended by an elastic band behind the Achilles tendon and fastens with Velcro for traction up to optimum position.

Indications:

- Hallux- valgus correction.

Colour: Beige.



Ref.: HV-33D RIGHT | Ref.: HV-33I LEFT

HALLUX-VALGUS IN THERMOPLASTIC

SIZES	FOOTWEAR SIZE
S/1	34-36
M/2	37-40
L/3	41-46

Characteristics:

Night-time corrector for bunions, manufactured in thermoplastic and velour, with micro-fastener seal. It includes a cushioning pad on the big toe which, together with the pressure strap, at the height of the bunion, maintains the first metatarsus aligned and in correct position during nighttime use, reducing pain and preventing its possible evolution.

Indications:

- Hallux- valgus correction.

Colour: Blue.





Ref.: CP01

POST OPERATIVE SHOE

SIZES	FOOTWEAR SIZE
XS/0	33-35
S/1	36-38
M/2	39-40
L/3	41-42
XL/4	43-45

Characteristics:

Made from breathable material and with an open toe, ideal for toe and forefoot surgery, with rigid reinforcement in the heel, ideal for heel afflictions.

Indications:

- Post foot and toe operations, for cases of difficulties in venous return (oedemas), when conventional footwear cannot be used.

Colour: ■ Black.



Ref.: CP02

POST-OPERATIVE TALIPES CALCANEUS SHOE

SIZES	FOOTWEAR SIZE
XS/0	33-35
S/1	36-38
M/2	39-40
L/3	41-42
XL/4	43-45

Characteristics:

Made from breathable material and with an open toe, ideal for toe and forefoot surgery, with rigid reinforcement in the heel, ideal for heel afflictions.

Indications:

- Post foot and toe operations, for cases of difficulties in venous return (oedemas), when conventional footwear cannot be used.
- Bandages that immobilise the tarsotibial joint, there by facilitating movement, especially in the lifting phase.

Colour: ■ Black.



Ref.: CP03

HEEL SHOE TACO

SIZES	FOOTWEAR SIZE
S/1	35-37
M/2	38-40
L/3	41-43

Characteristics:

Made from breathable material and with an open toe, ideal for toe and forefoot surgery, with rigid reinforcement in the heel, ideal for heel afflictions.

Indications:

- Particularly indicated in foot surgery enabling the load to be placed on the heel and preventing the load on the front of the foot.

Colour: ■ Black.



Ref.: CP04

POST-OPERATIVE SHOE (PARTICULARLY INDICATED FOR DIABETIC FOOT/ULCERS)

SIZES	FOOTWEAR SIZE
XS/0	33-35
S/1	36-38
M/2	39-40
L/3	41-42
XL/4	43-45

Characteristics:

Universal to fit either the right or left foot, non-slip rocker sole, Velcro closure system enabling it to accommodate large deformities or post-operative dressings, made from a breathable material. The front of the shoe features a toe cap that can be attached or removed according to the needs of the patient. Its versatility enables its existing insole to be replaced by an active off-loading insole.

Indications:

- Post-operative care of the foot and toes, in cases where it is not yet possible for the patient to wear conventional footwear due to venous return problems (oedema). Diabetic foot, plantar ulcers and other foot disorders when the off-loading insole is inserted.

Colour: ■ Black.

Special insole for diabetic foot and ulcerations

MAIN FEATURES



Overloading in the area of the ulcer (without insole)



Off-loading of the ulcer with the insole



Ref.: PANW (Walkers)



Ref.: PANCP (post-operative footwear)

SPECIAL INSOLE FOR DIABETIC FOOT AND ULCERATIONS

Ref.: PANW

SIZES	FOOTWEAR SIZE
S/1	36-39
M/2	40-42
L/3	43-45

Ref.: PANW designed for Walkers:

Ref.: EST-083, EST-086, EST-087, EST-088.

Ref.: PANCP

SIZES	FOOTWEAR SIZE
XS/0	33-35
S/1	36-38
M/2	39-40
L/3	41-42
XL/4	43-45

Ref.: PANCP designed for post-operative footwear Ref.: CP04.

Characteristics:

Composed of a velour base with a Velcro strip onto which is attached an insole consisting of hexagonal urethane (EVA) cells in 10 mm-thick slow-memory material, whose function is to relieve and reduce pressure areas, and a PORON lining that provides flexibility and the ability to absorb loads and impacts.

Function:

The hexagonal cells that form the insole are moveable, making it possible to detach those that are in contact with the ulcerated area or the zone that requires pressure relief. As ulcers are often migratory, the cells can be replaced or removed according to their position and healing process stage in order to vary pressure points. Pressure and load forces can be reduced by up to 60% in all phases of static and dynamic loading.

Indications:

- Plantar ulcers on the heel and forefoot.
- Neuropathies with the risk of plantar ulcers.
- Diabetic foot.
- Post-operative patients.
- Plantar warts after surgery.
- Plantar injuries.

Colour:

- Maroon.

“Orliven® cares for your legs”

TECHNICAL COMPRESSION SOCKS

Frequently in our busy daily working lives, from when we wake up until we go to bed, juggling family and work obligations, we tend to overlook the efforts made by our legs and forget to take care of them properly.

Sporting activities, jobs that require sitting or standing for a long time, seasonal changes, heredity, age, lifestyle, habits, etc., can result in tired or aching legs or venous problems that affect both men and women of all ages.

Orliven is the new brand of technical socks from Orliman, born from the philosophy of contributing to the welfare of the people, providing the required benefits and responding to a growing demand with 3 different ranges of socks.



Technical compression socks for general sports: running, cycling, triathlon, tennis, etc.



Technical compression socks for tired legs, overload and people who may suffer the well-known “tourist syndrome”.



Designed for diabetic foot. Prevent the growth of bacteria and fungi and have low compression to offer maximum comfort to the foot.



Why use compression socks?

- › Aid muscle recovery and reduce muscle aches and fatigue.
- › Improve venous return and blood circulation.
- › Breathable and keep a constant temperature of the lower limbs during physical exercise..
- › Provide protection and support against potential impacts.





MAIN FEATURES



UNISEX



GRADUAL
COMPRESSION



PROMOTES VENOUS
RETURN



SEAMLESS



BREATHABLE



1st
Triathlon World
Champion



Ref.: OV02D500 BLACK | Ref.: OV02D501 WHITE

SPORTS COMPRESSION SOCKS

SIZES	MEASURES	
	A-D cm HEIGHT	C cm MAXIMUM CALF CIRCUMFERENCE
S/1	36-40	30-34,5
M/2	36-40	34,5-39
L/3	36-40	39-43,5
XL4	36-40	43,5-48

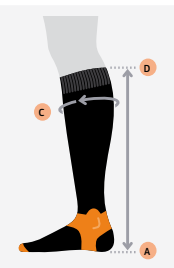

Ref.: OV02D500



Ref.: OV02D501

Characteristics:

- Improve venous return and muscle recovery.
- Reduce recovery time.
- Prevent against muscle injury.
- Allow the area to breathe and keep a constant temperature of the lower limbs.
- Provide greater protection for the most vulnerable areas (Achilles tendon, calves, toes and soles of the feet), minimising impact during sporting activities.
- Padded area at the top of the instep to avoid discomfort or chafing from shoes.

Composition:

72% Polyamide.
28% Lycra.

Colour:

OV02D500: Black.
OV02D501: White.

MAIN FEATURES



UNISEX



GRADUAL COMPRESSION



PROMOTES VENOUS RETURN



SEAMLESS



BREATHABLE



Ref.: OV01D500 BLACK

TRAVEL SOCKS

SIZES	MEASURES	
	A-D cm HEIGHT	B cm MINIMUM ANKLE CIRCUMFERENCE
S/1	36-40	18-21,5
M/2	36-40	21,5-25
L/3	36-40	25-28,5
XL4	36-40	28,5-32

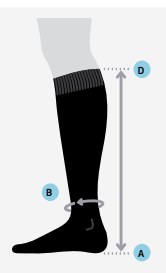

Characteristics:

- Stimulates and promotes venous return.
- Protects against possible impact injuries and abrasions on toes and heels.
- Recommended for long journeys.

Composition:

75% Polyamide.
25% Lycra.

Colour: ■ Black.



MAIN FEATURES

DAILY, SOCK FOR EVERYDAY USE



RELAX



UNISEX



WITHOUT COMPRESSION



WITHOUT SEAMS



SMOOTH KNIT FABRIC



BREATHABLE



BACTERIOSTATIC



ANTI-ODOUR



DAILY

Ref.: OV04B000

Composition:

- 85% Cotton with silver ions.
- 12% Polyamide.
- 3% Lycra.



RELAX

Ref.: OV03B005

Composition:

- 40% Bamboo charcoal.
- 40% Cotton with silver ions.
- 16% Polyamide.
- 4% Lycra.

Ref.: OV04B000 BLACK

Ref.: OV03B005 GREY

DIABETIC SOCKS

SIZES	MEASURES	
	SHOE SIZE	AB1 cm HEIGHT
S/1	36-38,5	18-22
M/2	38,5-41	18-22
L/3	41-43,5	18-22
XL4	43,5-46	18-22

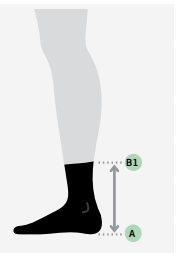

Characteristics:

- Prevent infections.
- Prevent the growth of bacteria and fungi (bacteriostatic treatment).
- Prevent chafing in delicate areas such as underneath the foot.
- Designed to prevent fungal infections and eczema.





ORLIMAN®

Advancing for your well-being

Advertising Material

EXHIBITORS

Thermomed



Ref.: EXP-NE-GRA (200 x 70 cm)
Large

Thermomed



Ref.: EXP-NE-PEQ (44 x 36 cm)
Small

Sofy-Plant Gel
Podology



Ref.: EXP-Gel-Cartón (67 x 34 cm)

Units: 36

Multi-Product Exhibitor



Sofy-Plant Gel
Podology



Ref.: EXP-SG (50 x 32 cm)

Units: 60

Orliven®
Calcetines Técnicas



Ref.: EXP-OV (39x25x17)

Units: 12

Ref.: EXP-GEN (180 x 33 cm)

Units: 36

Multi-Product Exhibitor



Ref.: EXP-MP (1,80 x 52 cm)

Units: 30-40 (Rigid Cardboard)

RECOMMENDED PACKS



Thermo-med® Line



Top Line



Thermo-med®
One Size +
ElasticLine

Advertising Material

EXHIBITORS

- Epitec Fix
Epicondylitis Armband



Ref.: Exp-e21-Cartón (50 x 20 cm)

Units: 10

- Hallux-Valgus



Ref.: EXP-HV33 (18 x 24 x 32 cm)

Units: 10

- Sofy Plant Fine *fine Lady*
Insoles



Ref: Exp-FINE-Cartón (34 x 25 cm)

Units: 14
Mod. PL-700F

- Thermo-med One Size Line



Ref.: Exp-ONE-Cartón (48 x 50 x 30 cm)

Units: 14

- Pad-Fix
Patellar knee band



Ref.: EXP-SP110 (13 x 22 x 17 cm)

Units: 10

- Sofy-Plant Gel
Podology



Ref.: Exp-SF-Carton (30 x 20 x 20cm)

Units: 10
(For any reference of Sofy-plant® Gel)

- Elastic Line



Ref.: EXP-ORL-ELASTIC (46 x 20 x 38 cm)

Units: 21

- Sofy Plant Fine (Insoles)



Ref.: Exp-FINE-Cartón (34 x 25 cm)

Units: 10
Mod. PL-701F

- ConforGel
Mini-plantar bands



Ref.: Exp-G204-Cartón (20 x 30 x 18 cm)

Units: 10

Advertising Material

CATALOGUES

Catalogue

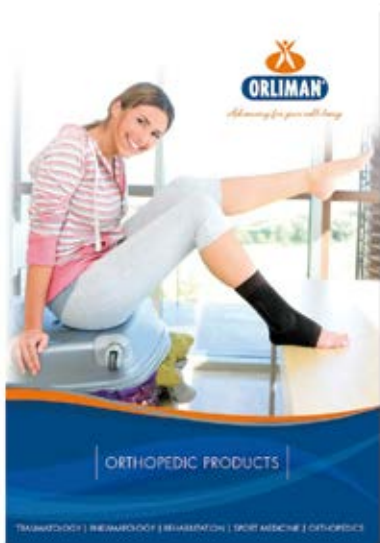

A4 (30x21 cm)
Ref: Cat-EXT

CD



PubliVaria + CD

Prescription Book



Ref.: Cat-RECE
(22x26 cm)

Pathology book

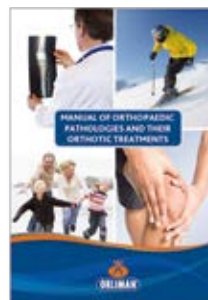

Ref.: Cat-LPI
(15x21 cm)

DISPLAYS/POSTERS



Ref.: TEC-ROD (50x70 cm)



Ref.: DISPLAY-FINE (20x15 cm)



Ref.: DISPLAY (Gel 1)
(41x29,7 cm)

MERCHANDISING



BROCHURES

Most represented products



Cat-TRIF (11x21 cm)



Sofy-Plant gel



Díptico-DPGG (16x16 cm)

Advertising Material



Catalogue Pediatric



Ref.: CAT/OPES
27x21 cm.

Small Display



Ref.: DISPLAYS OPD
12x18 cm. (double-sided)

Display



Ref.: DISPLAYS OPD 2
50x70 cm.

ORLIMAN[®] SPORT

Display

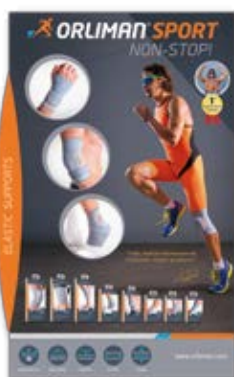

Ref.: DISPLAYS/OS
70 x 50 cm.

Catalogue Sport



Ref.: CAT/OSIF
29,7 x 21 cm.

Exhibitor



Ref.: EXP-OS-EX/GRA
160 x 60 cm
Units: 40

Display



Ref.: LIFE 7
100x60 cm.

Exhibitor



Ref.: EXP-OS-EX/PEQ
53 x 30 cm
Units: 20

Advertising Material

DISPLAYS/TOTEMS

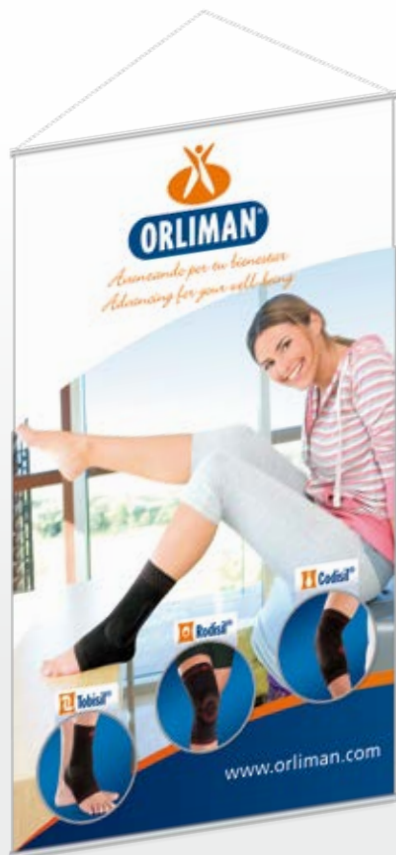

■ Life 4
Ref.: LIF4
(100x60 cm)



■ Arnetec
Ref.: ARN
(100x60 cm)



■ Life 6
Ref.: LIF6
(36x70 cm)





ORLIMAN[®]



Advancing for your well-being

ORLIMAN S.L.U.
ORTHOPEDIC PRODUCTS

C/ Ausias March, 3 - 46185 La Pobla de Vallbona · Valencia (Spain)

Tel.: +34 96 272 57 04 - Fax: +34 96 275 87 00

E-mail: orto@orliman.com · www.orliman.com

EDITION 04/2014



ISO 13485



005



005



(00)cat#ext(10)M0000